



To: Members of the Board of Adjustment, Applicants & Neighboring Property Owners
From: Jonathan B. Kanipe, Town Manager
Date: April 11, 2025
Re: **Board of Adjustment Meeting – April 21, 2025**

Applicants:

You or a representative **MUST** attend the meeting to have the matter considered.

Members of the Board of Adjustment & staff will conduct a site visit prior to the meeting. Site visit times listed are approximate.

Neighbors:

You are receiving this notice because your property is adjacent to an applicant on this month's agenda.

You may review applications & plans for the projects on this agenda at <http://www.biltmoreforest.org/board-of-adjustment>

You are invited to attend the scheduled meeting at the Town Hall and make comment when called upon.

Additional information regarding the meeting will be provided on the Town's website no later than April 18th, 2025.

*****PROPOSED AGENDA*****

The following items of business will be considered by the Biltmore Forest Board of Adjustment on Monday, April 21st, 2025 at 4:00 p.m. at the Biltmore Forest Town Hall at 355 Vanderbilt Road, Biltmore Forest, NC 28803.

1. The meeting will be called to order and roll call taken.
2. The minutes of the February 17, 2025 regular meeting will be considered.
3. Hearing of Cases (Evidentiary Hearings, Deliberations & Determinations).

Case 1: 85 Chauncey Circle- Variance request for an accessory structure (swim spa) in the front yard.

Site visit: 2:45 pm

Case 2: 6 Fairway Place- Variance request for a fence in the side/rear yard setbacks.

Site Visit – 3:05 pm

Case 3: 14 Stuyvesant Road-Variance request for a garage addition in adjusted setbacks.

Site Visit – 3:25pm

Case 4: 49 Forest Road-Variance request for multiple accessory structures in the front of the home.

Site Visit- 3:40pm

MINUTES OF THE BOARD OF ADJUSTMENT
MEETING HELD MONDAY, FEBRUARY 17, 2025

The Board of Adjustment met at 4:00 p.m. on Monday, February 17, 2025

Chairman Greg Goosmann, Ms. Martha Barnes, Ms. Lynn Kieffer, Mr. Robert Chandler, Ms. Rhoda Groce, and Ms. Janet Whitworth were present. Mr. Tony Williams, Town Planner, Mr. Jonathan Kanipe, Town Manager, and Town Attorney Mr. Billy Clarke were also present.

Chairman Greg Goosmann called the meeting to order at 4:00 p.m.

Mr. Chandler made a motion to approve the minutes from the January 20th, 2025 meeting.

Ms. Groce seconded and unanimously approved.

Chairman Goosmann swore in the following:

Mr. Jonathan Kanipe

Mr. Tony Williams

Mr. Phil Harding

Ms. Laura Wrenn

Mr. Rick Jackson

Mr. Mark Dorsey

Mr. Doug Colvard

Mr. William Baudhuin

Ms. Julie Tatar

HEARING (Evidentiary):

The first matter is a Variance request for encroachment of an accessory structure into the side yard setback as well as an accessory structure located within the front yard at 2 Cedar Hill Drive. The property owners request permission to install attached accessory structures within the front yard and one detached accessory structure in the side yard. The proposed attached accessory structure is a retaining wall and encroach into the side yard setbacks. A pool with a retaining wall. The retaining wall is a few feet into the setback. The front setback is 75 feet instead of 60 feet. They are proposing to add a bigger front-covered porch. Materials and style will match the house. It will come out about twelve feet. This will not be visible from the road. There will be five trees that are going to be removed but they will be replaced with additional landscaping. The reason for putting this in the front of the house is because there would be much more disruption to the vegetation and their neighbors to the rear. Lynn said this is the least conspicuous spot to put this pool.

DELIBERATION AND DETERMINATION:

Mr. Williams restated the facts and said the detached and attached accessory structure. Retaining wall and a pool, retaining wall, fence and gates which does not encroach into the setbacks. The encroachment

Ms. Martha Barnes made a motion to approve a Variance for a dry wall retaining wall, a Variance for a pool, walls, and the facts as recited by Tony Williams and his summation be accepted as findings and facts to support this grant. She further, she moved that by granting this Variance further satisfies the applicable Sections of 153.110(D) and paragraphs one through four and would not be contrary to the public interest where, owing to special conditions, a literal enforcement of the provisions of this Ordinance would, in this case, result in practical difficulty or unnecessary hardship. She further moved the Board to find the spirit of the ordinance would be observed, public safety and welfare secured, and substantial justice done. The applicant has been informed that he/she is to report to the Zoning Administrator within seven (7) days of

completion of the project in order that the Zoning Administrator can determine that the project has been completed in accordance with plans submitted to the Town.

Ms. Rhoda Groce seconded the motion and was unanimously approved.

HEARING (Evidentiary):

The second matter is for a Variance request for fence installation within the setbacks at 28 Ridgefield Place. Mr. Williams said they would like to install a fence in the rear and side yard setback. They would like to install a six foot fence. It would be wooden and be on the back yard perimeter. They are also going to install privacy buffering on the outside of the fence.

DELIBERATION AND DETERMINATION:

Mr. Williams restated the facts and said the property owners at 28 Ridgefield Place in the rear and side yard. It would be a wooden privacy fence.

Ms. Kieffer moved that by granting this Variance at 28 Ridgefield Place and the facts as recited by Tony Williams and his summation further satisfies the applicable Sections of 153.110(D) and paragraphs one through four and would not be contrary to the public interest where, owing to special conditions, a literal enforcement of the provisions of this Ordinance would, in this case, result in practical difficulty or unnecessary hardship. She further moved the Board to find the spirit of the ordinance would be observed, public safety and welfare secured, and substantial justice done. The applicant has been informed that he/she is to report to the Zoning Administrator within seven (7) days of completion of the project in order that the Zoning Administrator can determine that the project has been completed in accordance with plans submitted to the Town.

Mr. Robert Chandler seconded the motion and was unanimously approved.

HEARING (Evidentiary):

The third matter is for a Rehearing of a Special Use and Variance request for an accessory in the front yard at 56 Forest Road. The structures will include an

Will be included in the front setback. This will help with erosion control. The lanterns do not need to be addressed because it is considered lighting. They will not approve the statue. Homeowner said she would that part withdrawn from the application. Ms. Laura Wrenn asked about the water feature and the Variance. Mr. Chandler asked about the rocks with erosion control.

DELIBERATION AND DETERMINATION:

Landscaping boulders 3-4' and 18" in height and four landscape boulders and a retaining wall with the approximate height of 2.5' Mr. Williams restated the facts and said the and the facts as recited by Tony Williams and his summation be accepted as findings and facts to support this grant. Ms. Rhoda Groce made a motion The Board has inspected this site, and no neighboring property owner has objected. She further moved the Board define that granting this Special Use Permit (a) would not materially endanger the public health or safety if located where proposed and developed according to the plans as submitted and improved, (b) met all required conditions and specifications of the Town of Biltmore Forest Zoning ordinance, (c) would not substantially injure the value of adjoining or abutting property, and (d) would be in general conformity with the plan of development of the Town of Biltmore Forest and its environs as set forth in Sections 153.110 (C)(2-3) of the above ordinance. The applicant has been informed that he/she is to report to the Zoning Administrator within seven (7) days of completion of the project in order that the Zoning Administrator can determine that the project has been completed in accordance with plans submitted to the Town.

Further, he moved that by granting this Variance further satisfies the applicable Sections of 153.110(D) and paragraphs one through four and would not be contrary to the public interest where, owing to special conditions, literal enforcement of the provisions of this Ordinance would, in this case, result in practical difficulty or unnecessary hardship. She further moved the Board to find the spirit of the ordinance would be observed, public safety and welfare secured, and substantial justice done. The applicant has been informed that he/she is to report to the Zoning Administrator within seven (7) days of completion of the project in order that the Zoning Administrator can determine that the project has been completed in accordance with plans submitted to the Town.

Ms. Lynn Kieffer seconded the motion. The motion was unanimously approved.

.

The next meeting is scheduled for Monday, March 17, 2025 at 4:00pm.

The meeting was adjourned at 4:39 pm.

ATTEST:

Greg Goosmann

Chairman

Laura Jacobs

Town Clerk



BOARD OF ADJUSTMENT MEETING

STAFF MEMORANDUM

April 21, 2025

CASE 1

Property Address: 85 Chauncey Circle

Property Owner: Georgia DeMauro

Request: Hearing for Variance Request for Accessory Structure

Background

The owner is presenting plans for a swim spa to be located within the front yard. The spa will be one hundred seventy-nine inches by ninety inches. The spa appears to meet the front and side setbacks but not the approved location for accessory structures. The application does not meet all the requirements set forth in the ordinance, therefore it would require a variance.

Variance

The proposed swim spa does not meet the ordinance for being located in the rear yard and therefore would require a variance. Section 153.110 (D) (attached) addresses the approval requirements for a variance.

Zoning Compliance Application

Town of Biltmore Forest

Name

Georgia DeMauro DeMauro

Property Address

85 Chauncey Circle

Phone

(561) 722-6608

Email

georgiademauro@gmail.com

Parcel ID/PIN Number

I'm unable to find it at this time. Sorry!

ZONING INFORMATION

Current Zoning

R-3

Lot Size

1.3

Proposed Roof Coverage Total

0

Proposed Impervious Surface Coverage

129 inches x 90 inches

Front Yard Setback

50 feet (R-2, R-3, R-4, and R-5 Districts)

Side Yard Setback

15 feet (R-2, R-3, R-4, and R-5 Districts)

Rear Yard Setback

20 feet (R-2, R-3, R-4, and R-5 Districts)

Building Height

4feet

Description of the Proposed Project

Swim spa

Estimated Start Date

5/1/2025

Estimated Completion Date

5/22/2025

Estimated Cost of Project

\$30,000.00

Supporting Documentation (Site Plan, Drawings, Other Information)

Applicant Signature

Date
3/31/2025

Georgia DeMauro

VARIANCE APPLICATION

Town of Biltmore Forest

Name

Georgia DeMauro

Address

85 Chauncey Circle

Phone

(561) 722-6608

Email

georgiademauro@gmail.com

Current Zoning/Use

Residential

Requested Use

Swim spa

APPLICATION REQUIREMENTS: An application to the Board of Adjustment for a variance must be submitted to the Town of Biltmore Forest Town Manager at least 21 days prior to the meeting at which the application will be considered. A pre-application meeting with Town staff is required prior to application submittal to the Board of Adjustment.

What would you like to do with your property?

Swim spa

What does the ordinance require?

Small jacuzzi like structure 179" x 90"

BOARD OF ADJUSTMENT: N.C.G.S. 160A-388(D) requires that the Board of Adjustment shall vary the provisions of the Zoning Ordinance only upon a showing of ALL the items below. The Board of Adjustment must follow strict procedure and all determinations must be decided by a concurring vote of four-fifths of the members of the Board. It is important to provide detailed supporting documentation for the Board of Adjustment to review. If necessary, additional sheets may be attached to this application.

REQUIRED FINDINGS: Please provide a thorough response to each.**Unnecessary hardship would result from the strict application of the ordinance.**

Difficult to put in the back of the house because of the steep slope and no truck accessibility because of the large trees.

The hardship results from conditions that are peculiar to the property, such as location, size, or topography.

Because of the steep slope and trees, difficult to get equipment to the back of the house. I will be planting large trees and shrubs to hide the swim spa from the street and my neighbor. I personally prefer privacy when I'm in this wind spa as well.

The hardship did not result from actions taken by the applicant or the property owner.

No, the hardship is not of my doing. It was difficult access to begin with.

The requested variance is consistent with the spirit, purpose, and intent of the ordinance, such that public safety is secured, and substantial justice is achieved.

I feel that I am in compliance with Biltmore Forest and Ramble, aesthetics and quality of project

I hereby certify that all of the information set forth above is true and accurate to the best of my knowledge.

Signature

Date

Georgia DeMauro

Have you paid the \$300 variance application fee? Your permit application will not be reviewed until payment has been received. You can visit the link below to pay. Copy & paste the link in your browser.

I plan to pay in person or mail a check

neighbor property line

DRIVEWAY

85 CHAUNCEY CIRCLE

GARAGE

HOUSE

FRONT DOOR

GRASS AREA

SCREEN PORCH

OUTSIDE PATIO

SWIM SPA

STEPS DOWN

STEPS DOWN

90"

179"

TRUCK DELIVERY ACCESS

HOLLY TREE

HOLLY TREE

HOLLY TREE

HOLLY TREE

HOLLY TREE

PROPERTY LINE



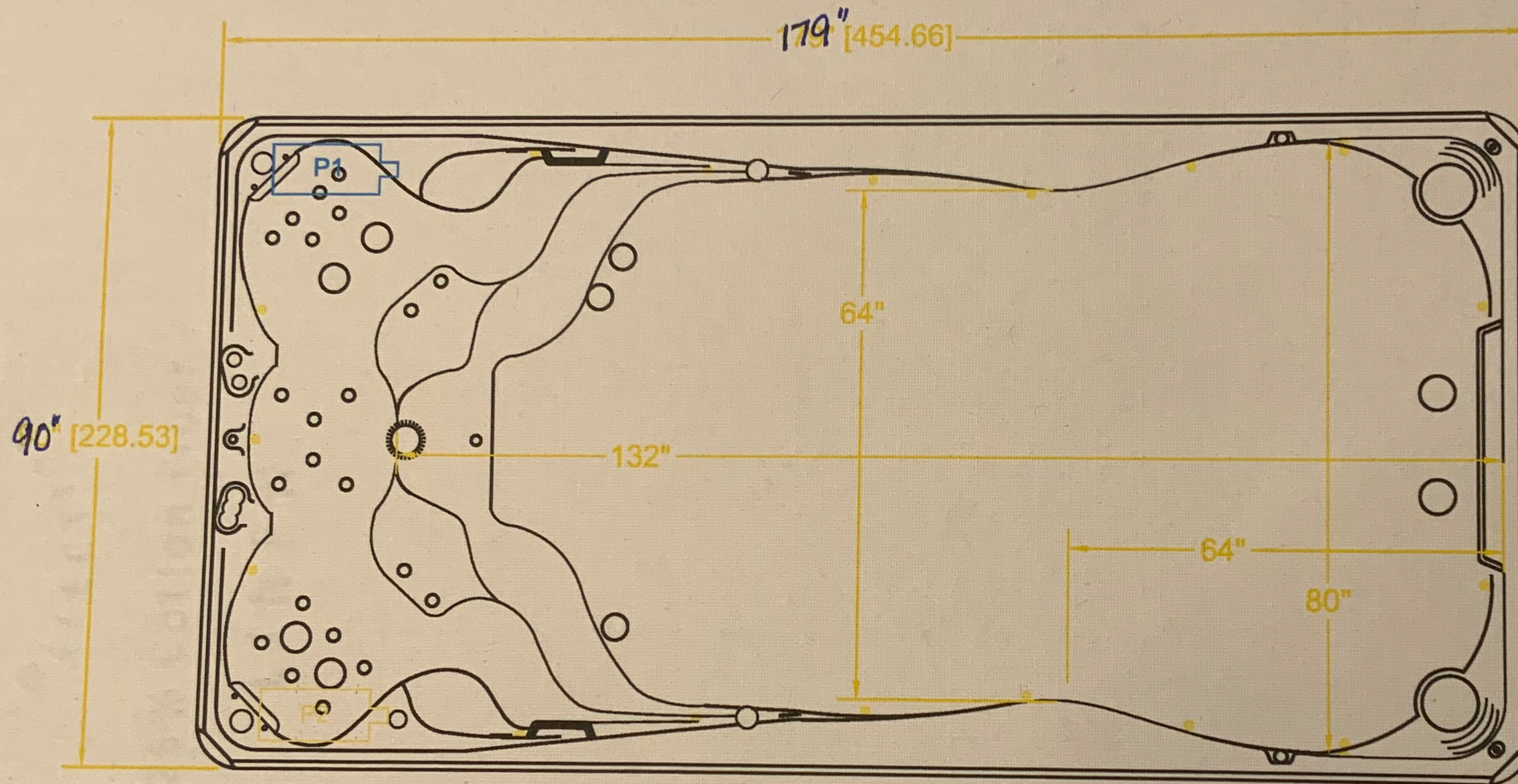

cover included

Outline

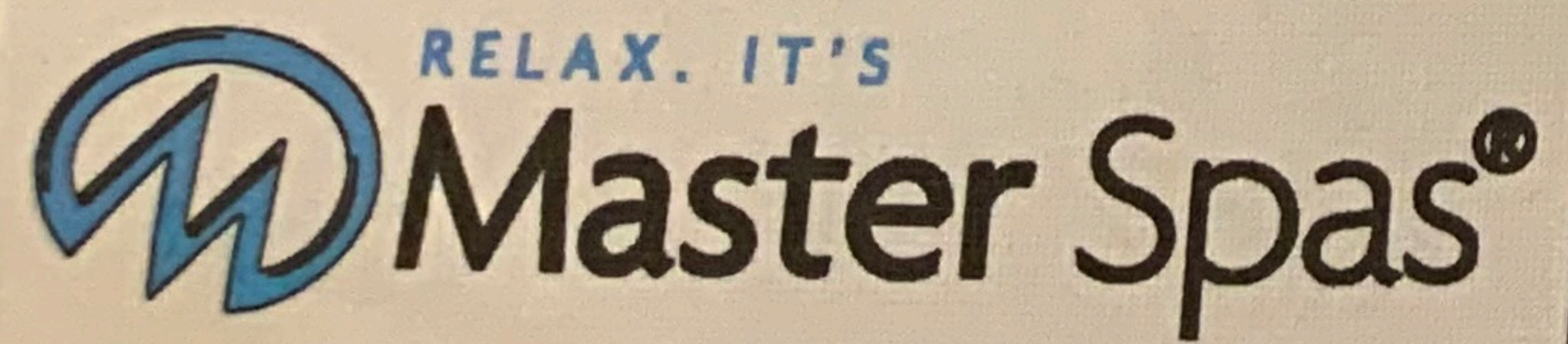

Rev.	Date	Description	By
00	1/13/25	Original Drawing Reset	MWE

DO NOT SCALE DRAWING

Year: 2025	Model: Therapool 15
Height: 51" ± 1/2"	Brand: H2X
Drawn By: Easley	Date: 1/13/25

THE
RAMBLE
BILTMORE FOREST

*If you are an owner on Chauncey and Niagara, please be sure to also check the Town Of Biltmore Forest website for further regulations, <https://www.biltmoreforest.org/home-1>.

Description of Improvement: for 85 Chauncey Circle

I would like to install a swim spa on the side of the house. It can be rolled in by truck and set into place. Size 90" X 179" w/ cover

I will have a concrete pad w/ reinforced steel to set the swim spa on.

I will have an electrician run a 220v. wire from my breaker box thru my basement to the spa for electricity.

The spa can be filled with a garden hose.

The holly trees (5) will help block any view of the spa (from the street, and neighbor)

Thank you for your time and review of the plans.

Please call me on my cell phone @
561-722-6608
or

email - georgiademauro @ gmail . com

Regards

Georgia DeMauro

**THE
RAMBLE
BILTMORE FOREST**

Design Review Application Form

This form is for approval of improvements to the exterior of existing homes. Please submit this application with all documentation to your management company prior to scheduling work to begin. Architectural improvements must be approved by the Design Review Committee. The DRC meets on the third Thursday of every month. The deadline for requests is on the second Wednesday of every month. The DRC may review applications weekly via their weekly phone conferences.

The following needs to be submitted (electronically, preferred) with this request:

1. This application form.
2. Application Fees as applicable. Please see the attached fee schedule.
3. ALL items required for your request. Please see the below requirements. *Additional information may be required.*

Homeowner Name: Georgia DeMauro Date of Request: _____
 Address: 85 Chauncey Circle Lot #: _____
 Email Address: georgiademauro@gmail.com

Applying For	Information Required						
	Landscape Plant List	Color Samples	Style and Materials	Site Drawing *	Number & Condition	Roof Placement*	Photos*
Tree Removal *Tree's should be marked							
✓ Landscape Enhancement							
Walks and Driveways							
Painting							
Porches & Decks							
✓ Accessory Structures							
Solar Panels							
Fences & Gates							
Exterior Lighting							

swim spa and plant
& Holly trees in front and 3
holly trees on side

*Site Drawing – Include property lines & setbacks
 *Roof Placement – Drawing includes panel placement, square footage coverage & road front
 *Email Photos to Evita Briceno, Evita.briceno@fsresidential.com.
 *If a General Contractor is involved for an exterior home renovation, please provide the contractors contact information. If a permit is issued, a time limit of 6 months with a \$5,000 Construction/Environmental Damage deposit is required. If there is any deviation from the time line, an extension request should be submitted to the Design Review Committee 30 days prior to the expiration date. It is the responsibility of the homeowner and contractor to ensure the time limit requirements is monitored.

Buncombe County

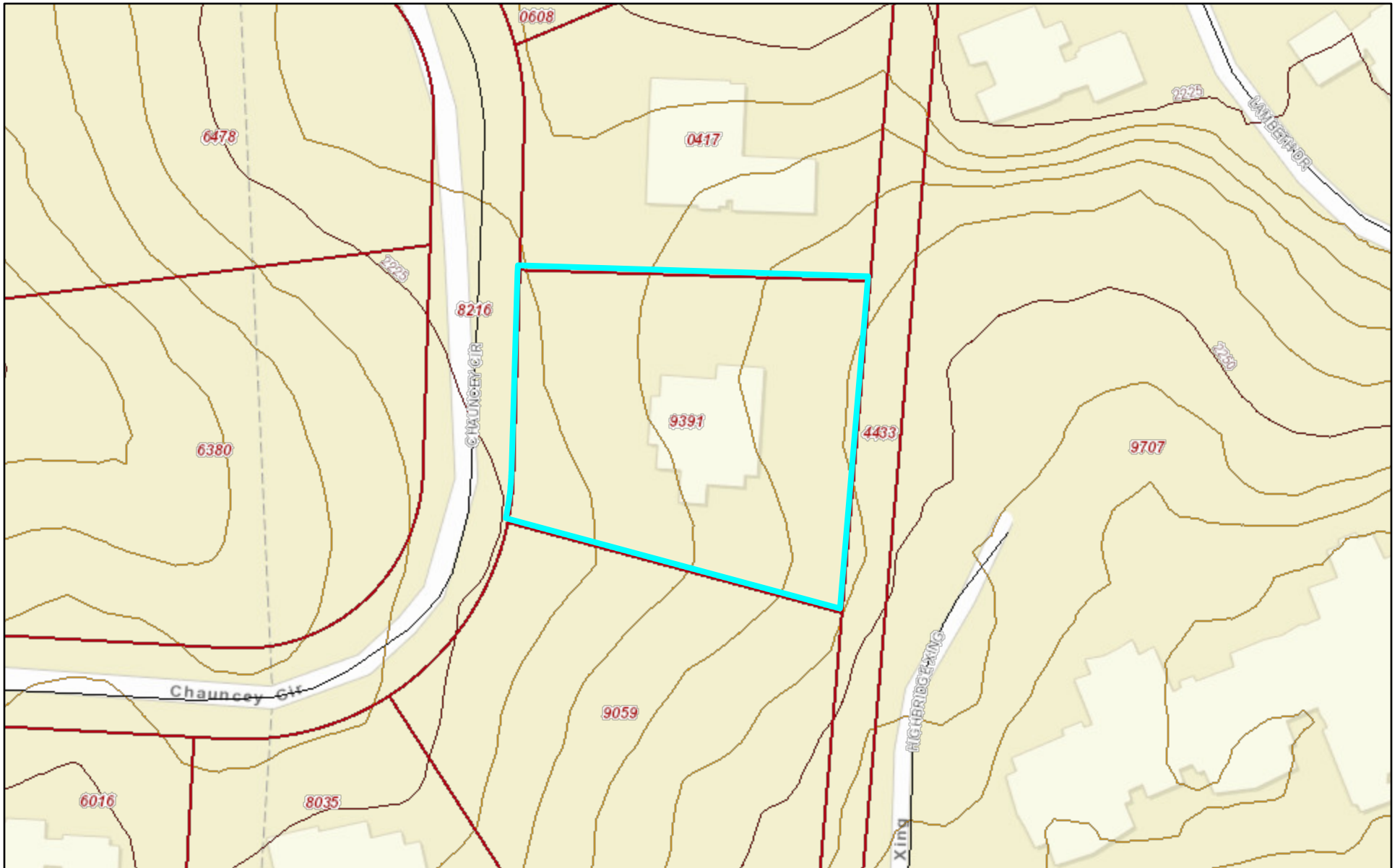

April 10, 2025

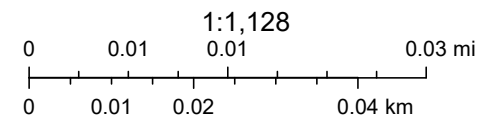

Sources: Esri, HERE, Garmin, USGS, Intermap, INCREMENT P, NRCan, Esri Japan, METI, Esri China (Hong Kong), Esri Korea, Esri (Thailand),



BOARD OF ADJUSTMENT MEETING

STAFF MEMORANDUM

April 21, 2025

CASE 2

Property Address: 6 Fairway Place

Property Owner: Bonnie Ellington

Request: Variance hearing for a Fence in the Side/Rear Yard Setbacks

Background

The property owners request permission to install a fence around their new pool within the rear yard. The proposed fence is part of a previously approved project. The fence will be black metal and built to meet the North Carolina Building Code. The fence will be located in the rear of the home, but it is being requested for an encroachment into the side setback ten feet and the rear setback eleven feet, therefore requires a variance.

Variance Request

The applicant is requesting to install the fence in the side yard and rear yard setbacks. The ordinance requires the fence to be located in the rear yard and not within any setbacks, therefore requires a variance. Section 153.110 (D) (attached) addresses the approval requirements for a variance.

153.029 ACCESSORY STRUCTURES AND BUILDINGS.

(A) Accessory structures and/or necessary buildings shall not detract from nor interfere with adjacent properties. No accessory structure or building shall be constructed, erected, or located within any front yard or within any side yard or rear yard setback.

(B) (1) In addition, the following standards are established for accessory structures and accessory buildings:

- (a) The maximum number of accessory buildings permitted on a lot shall be one;
 - (b) The maximum roof coverage area for accessory buildings shall be 750 square feet;
 - (c) The maximum height for accessory buildings shall be 25 feet;
 - (d) The accessory building must be screened by vegetation or other buffer as set forth in § [153.008](#);
 - (e) The accessory building must be located behind a line parallel to the rear of the principal structure on the lot;
 - (f) The accessory building must be designed in the same architectural style as the principal structure;
 - (g) Any accessory structure and/or accessory building shall be included in the calculation of allowable roof coverage and allowable impervious surface coverage on the lot pursuant to §§ [153.043](#) and [153.048](#); and
 - (h) Solar collectors shall be regulated in accordance with G.S. § 160D-914.
- (2) For all satellite dishes less than 24 inches in diameter, an application for a zoning compliance certificate shall be made directly to the Zoning Administrator; the Zoning Administrator shall issue a zoning compliance certificate.
- (3) Fences, gates, and walls shall be regulated in accordance with § [153.049](#) of this Zoning Ordinance.

(Ord. passed 10-19-1983; Ord. passed 6-8-2021)

Editor's note:

This amendatory language was passed during a Board meeting, July 9, 2013

Zoning Compliance Application

Town of Biltmore Forest

Name

Bonnie Ellington

Property Address

6 Fairway Place

Phone

(828) 989-4387

Email

susan@signature-llc.com

Parcel ID/PIN Number

964688801200000

ZONING INFORMATION

Current Zoning

R-1

Lot Size

1.149

Proposed Roof Coverage Total

0

Proposed Impervious Surface Coverage

0

Front Yard Setback

60 feet (R-1 District)

Side Yard Setback

20 feet (R-1 District)

Rear Yard Setback

25 feet (R-1 District)

Building Height

0

Description of the Proposed Project

pool barrier variance request

Estimated Start Date

4/22/2025

Estimated Completion Date

4/25/2025

Estimated Cost of Project

\$10,000.00

Supporting Documentation (Site Plan, Drawings, Other Information)

pool fence.docx

2025-03-18 Ellington Residence - Fence Variance Request.pdf

site plan with requested fence variance.pdf

Applicant Signature

Date
3/28/2025

S Turner

VARIANCE APPLICATION

Town of Biltmore Forest

Name

Bonnie Ellington

Address

6 Fairway Place

Phone

(828) 989-4387

Email

susan@signature-llc.com

Current Zoning/Use

Residential

Requested Use

Pool fence/ barrier variance

APPLICATION REQUIREMENTS: An application to the Board of Adjustment for a variance must be submitted to the Town of Biltmore Forest Town Manager at least 21 days prior to the meeting at which the application will be considered. A pre-application meeting with Town staff is required prior to application submittal to the Board of Adjustment.

What would you like to do with your property?

We would like to set the pool fence/ barrier within the current side and back yard setback

What does the ordinance require?

side yard set back is currently 20' and back yard is 25'

BOARD OF ADJUSTMENT: N.C.G.S. 160A-388(D) requires that the Board of Adjustment shall vary the provisions of the Zoning Ordinance only upon a showing of ALL the items below. The Board of Adjustment must follow strict procedure and all determinations must be decided by a concurring vote of four-fifths of the members of the Board. It is important to provide detailed supporting documentation for the Board of Adjustment to review. If necessary, additional sheets may be attached to this application.

REQUIRED FINDINGS: Please provide a thorough response to each.**Unnecessary hardship would result from the strict application of the ordinance.**

The design and construction of the retaining wall had to sit directly on the current setback to allow space for the homeowners to have a pool constructed within their small back yard.

The hardship results from conditions that are peculiar to the property, such as location, size, or topography.

This properties unique characteristics, topography, existing vegetation and location adjacent to the golf course has dictated the construction of the pool into a bank which created a need for a 5' retaining wall immediately within the current setbacks. The placement of the pool was dictated predominately by a protected tree and its root system. There was also a desire to keep the pool within a more private location to avoid any disruption for the club members utilizing the golf course.

The hardship did not result from actions taken by the applicant or the property owner.

For the homeowner to be able to enhance and fully utilize their property they had to build within the requested area keeping within the current ordinances, required protection of an existing tree and desired privacy for the golf course

The requested variance is consistent with the spirit, purpose, and intent of the ordinance, such that

public safety is secured, and substantial justice is achieved.

We do believe that granting this variance aligns with the spirit, purpose and intent of the ordinance while also achieving substantial justice. We also feel that granting this variance will insure public safety allowing for vegetation/ screening and avoiding up to an an 11' vertical wall and barrier.

I hereby certify that all of the information set forth above is true and accurate to the best of my knowledge.

Signature

Date

3/28/2025

A handwritten signature in cursive script that reads "S Turner".

Have you paid the \$300 variance application fee? Your permit application will not be reviewed until payment has been received. You can visit the link below to pay. Copy & paste the link in your browser.

Yes



March 18, 2025

Town of Biltmore Forest

Re: Fence Variance

To preserve and enhance the character of Biltmore Forest's unique residential community, I respectfully request a variance to construct a 4-foot-tall fence within the rear and side setbacks of the property located at 6 Fairway Place. While the fence's design meets all zoning requirements, it does not comply with the restrictions regarding its location within the property's setback area. However, I believe that granting this variance aligns with the spirit, purpose, and intent of the ordinance, ensuring public safety while also achieving substantial justice.

The unnecessary hardship pertains specifically to this property and is closely related to its unique characteristics, including the lot's topography, existing vegetation, and its location adjacent to the golf course. The pool currently under construction is situated on the steep rear slope of the property, ensuring privacy for both the homeowners and members of the Biltmore Forest Country Club, who play on the adjacent golf course. This design choice promotes visual harmony between areas of differing land uses and activities.

However, the steep slope has made it necessary to construct a retaining wall that is five feet high. Adhering to local ordinances when building the fence will significantly limit the practical use of the backyard space and result in an unattractive appearance. Without this variance, the fence would be placed directly on top of the retaining wall, leaving no room for vegetation to soften the hard surfaces. The total vertical height of these structures would reach nine feet, creating an unsightly view for both the homeowners and the members of the Biltmore Forest Country Club, which does not align with the community's aesthetic.

If approved, the fence variance would be consistent with and aimed at preserving the existing character of the neighborhood.

This variance is essential for maintaining and improving the community's aesthetic appeal. The proposed landscape design is in harmony with the neighborhood's character. It aims to preserve green spaces by promoting native vegetation, enhancing biodiversity and wildlife, and improving the community-designated bird sanctuary. The proposed fence location will also provide a buffer strip and screening between the amenity areas, creating a pleasant living environment for both homeowners and Biltmore Forest Country Club members. Additionally, it will establish natural buffers between residential and non-residential developments, helping to protect the community's ambiance.

Granting this variance would allow The Ellington Residence to fully utilize the property while respecting the intent of the R-1 District, which aims to preserve and enhance the character of existing neighborhoods and provide a pleasant living environment. I appreciate your consideration.

Kelly Cowan
Founder, Landscape Designer
Habitat Land Planning

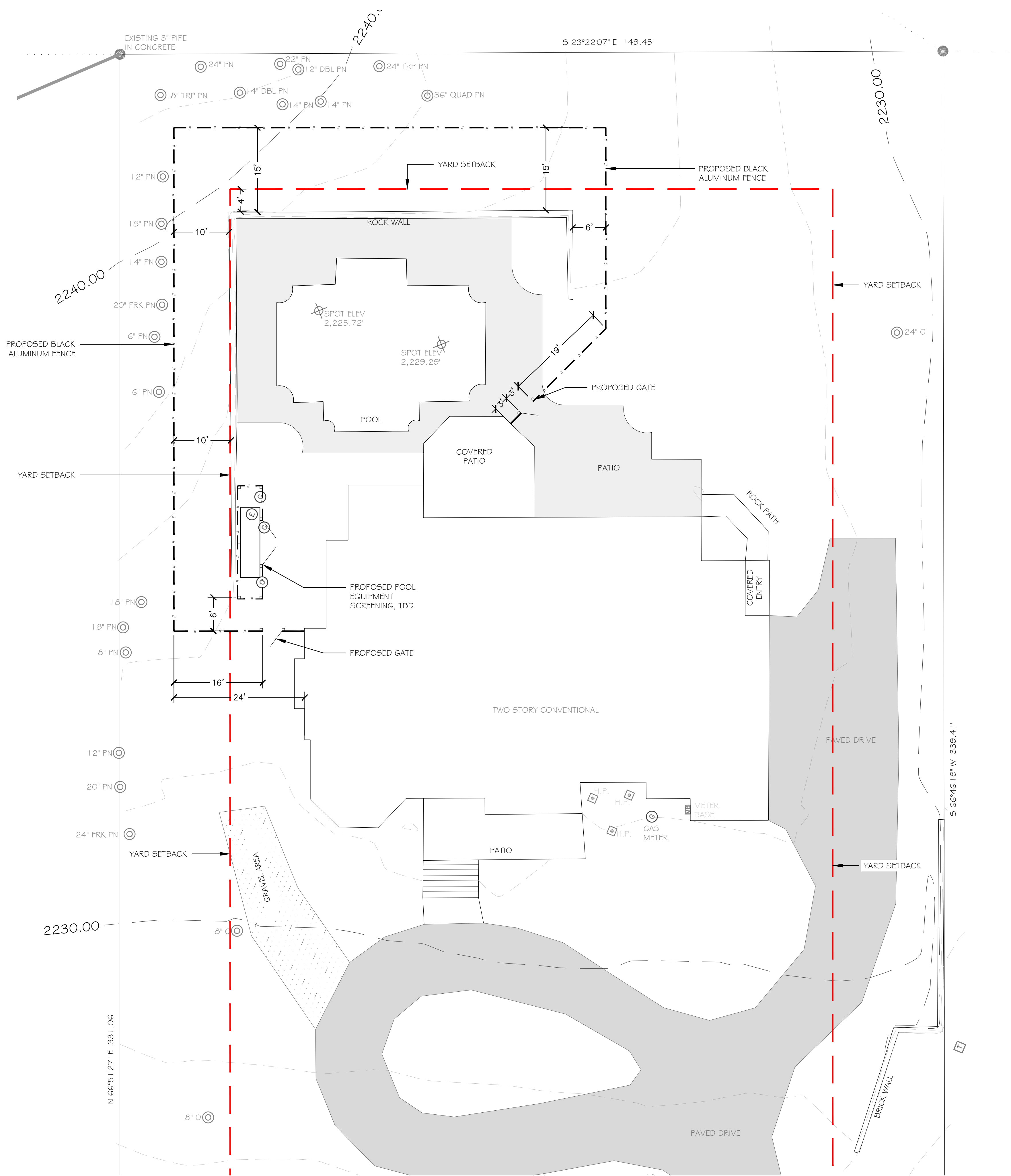

PIN: 9646-88-8012
 PROJECT LOCATION: 6 FAIRWAY PLACE
 PIN: R-1
 BUILDING USE: RESIDENTIAL
 TOTAL SITE AREA: 1.14 ACRES (49,658 SF)

ELLINGTON RESIDENCE

HABITAT LAND PLANNING
 24 W. 11th St., Ste. 200
 Asheville, North Carolina 28801
 www.habitatlandplanning.com

DEVELOPMENT DATA	
ALUMINUM FENCE	(LINEAR FEET) 265

PROGRESS PRINT - NOT FOR REGULATORY APPROVAL, PERMITTING OR CONSTRUCTION

CONCEPTUAL FENCE LAYOUT PLAN
 6 FAIRWAY PLACE
 BILTMORE FOREST, NORTH CAROLINA

DATE ISSUED:	FEBRUARY 18, 2025
REVISIONS:	FEBRUARY 26, 2025
	MARCH 18, 2025

SHEET: L1.03

Call Before You Dig
 Dial 811
 Or Call 1-800-282-7411

VERIFY LOCATION OF EXISTING UTILITIES PRIOR TO ANY GRADING OR SITE WORK. NOTIFY OWNER OF ANY CONFLICTS.

NORTH

GRAPHIC SCALE

(IN FEET)
 1 inch = 10 ft.

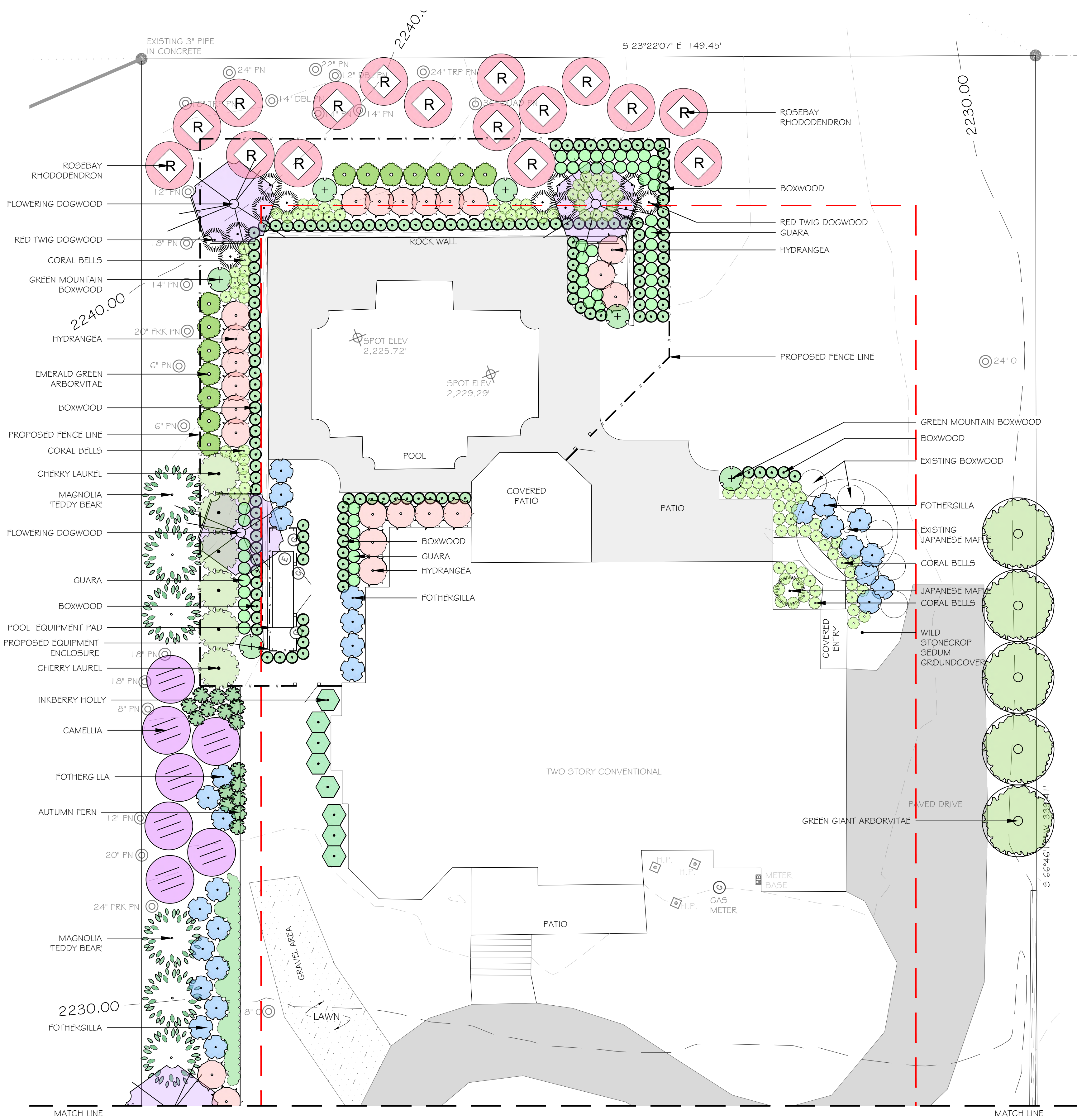

PLANT SCHEDULE

EVERGREEN TREES				
KEY	TOTAL	SPECIES	COMMON NAME	SIZE
	7	Camellia sasanqua	Camellia	B4B, 5'-6' Ht., Well-Branched
	6	Magnolia grandiflora 'Teddy Bear'	Teddy Bear Magnolia	B4B, 5'-6' Ht., Well-Branched
	5	Thuja occidentalis 'Green Giant'	Green Giant Arborvitae	B4B, 8'-9' Ht., Well-Branched
	14	Thuja occidentalis 'Emerald Green'	Emerald Green Arborvitae	B4B, 5'-6' Ht., Well-Branched

DECIDUOUS TREES				
KEY	TOTAL	SPECIES	COMMON NAME	SIZE
	1	Acer platanum	Japanese Maple	B4B, 3'-4' Ht., Well-Branched
	7	Cornus florida	Flowering Dogwood	B4B, 5'-6' Ht., Well-Branched
	2	Hamamelis virginiana	Common Witch Hazel	7 Gallon, 2.5'-3' Ht., Well-Branched
	2	Magnolia grandiflora 'Jane'	Magnolia 'Jane'	B4B, 5'-6' Ht., Well-Branched

SHRUBS				
KEY	TOTAL	SPECIES	COMMON NAME	SIZE
	9	Buxus x 'Green Mountain'	Green Mountain Boxwood	B4B, 2'-3' Ht.
	146	Buxus sempervirens 'Suffruticosa'	Dwarf English Boxwood	5 or 7 Gallon
	12	Cornus sencea	Red Twig Dogwood	5 Gallon
	35	Fothergilla gardenii	Dwarf Fothergilla	3 Gallon
	43	Hydrangea arborescens	Snowball Hydrangea	7 Gallon
	8	Ilex glabra 'Shamrock'	Dwarf Inkberry Holly	7 Gallon
	11	Prunus laurocerasus 'Schipkaensis'	Cherry Laurel	10 Gallon
	33	Rhododendron maximum	Rosebay Rhododendron	B4B, 5'-6' Ht., Well-Branched

HERBACEOUS PERENNIALS & ORNAMENTAL GRASSES				
KEY	TOTAL	SPECIES	COMMON NAME	SIZE
	26	Amsonia hubrichtii	Amsonia 'Blue Star'	1 Gallon
	54	Gaura lindheimeri 'Whirling Butterflies'	Gaura	1 Gallon
	102	Heuchera	TBD	1 Gallon
	81	Symphotrichum oblongifolium 'Raydon's Favorite'	Aster 'Raydon's Favorite'	1 Gallon
	65	Andropogon ternarius 'Black Mountain'	Black Mountain Bluestem	1 Gallon

FERNS & GROUNDCOVERS				
KEY	TOTAL	SPECIES	COMMON NAME	SIZE
	163	Dryopteris erythrosora	Autumn Fern	1 Gallon

BULBS				
KEY	TOTAL	SPECIES	COMMON NAME	SIZE
	80	Tulipa White Emperor	Tulip	Bulbs

HARDSCAPE			
KEY	TOTAL	MATERIAL	SIZE
	30 cu. yd.	Mulch	Double Ground Hardwood
		River Rock	Spring Creek 2" - 5"
		Flat Stone Steppers	TBD

PIN: 9646-88-8012
 PROJECT LOCATION: 6 FAIRWAY PLACE
 PIN: R-1
 BUILDING USE: RESIDENTIAL
 TOTAL SITE AREA: 1.14 ACRES (49,658 SF)

ELLINGTON RESIDENCE

HABITAT LAND PLANNING, INC.
 24 WALL STREET, SUITE 200
 ANNEVILLE, NORTH CAROLINA 28001
 www.habitatlandplanning.com

PROGRESS PRINT - NOT FOR REGULATORY APPROVAL, PERMITTING OR CONSTRUCTION

CONCEPTUAL PLANTING PLAN
 6 FAIRWAY PLACE
 BILTMORE FOREST, NORTH CAROLINA

DATE ISSUED:
 FEBRUARY 18, 2025
 REVISIONS:
 FEBRUARY 26, 2025
 MARCH 18, 2025

SHEET: L1.01
 COPYRIGHT © HABITAT LAND PLANNING, LLC

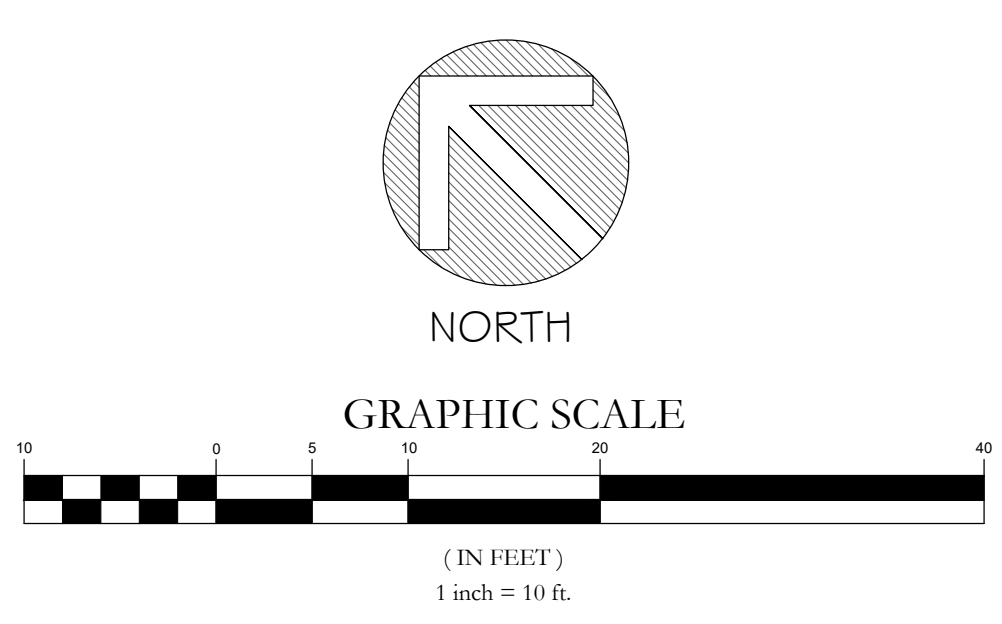

811 Call Before You Dig
 Dial 811
 Or Call 1-800-282-7411
 VERIFY LOCATION OF EXISTING UTILITIES
 PRIOR TO ANY GRADING OR SITE WORK.
 NOTIFY OWNER OF ANY CONFLICTS.

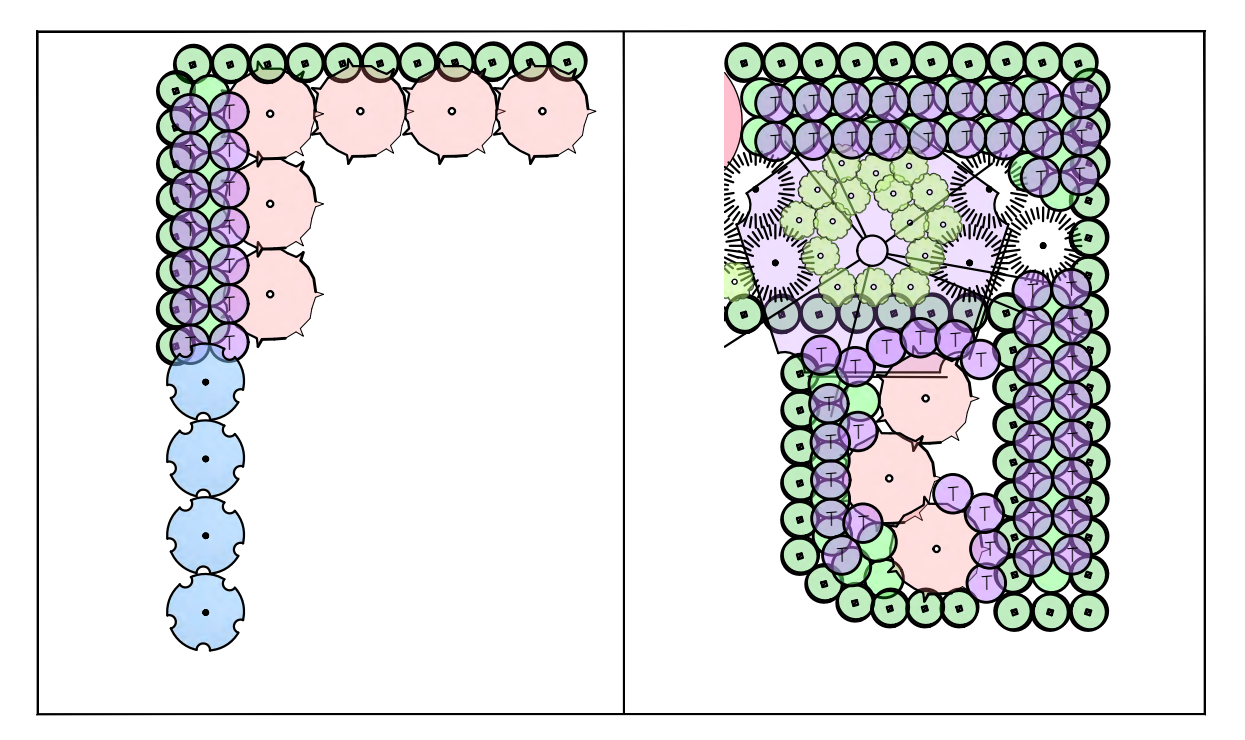

LANDSCAPE BEDS INTERPLANTED WITH TULIPS





BOARD OF ADJUSTMENT MEETING

STAFF MEMORANDUM

April 21, 2025

CASE 3

Property Address: 14 Stuyvesant Road
Property Owner: Donna and Jeff Loftin
Request: Hearing for Variance Request for Addition

Background

The owner is presenting plans for an addition on their garage. There was a previous variance approval for this project, however the owners have changed the location of the garage for this proposal. The proposed addition will encroach into the adjusted side setback twelve feet. The application does not meet the requirements set forth in the ordinance, therefore it would require a variance.

Variance

The proposed addition does not meet the ordinance requirement to be located outside of the setbacks and therefore would require a variance. Section 153.110 (D) (attached) addresses the approval requirements for a variance.

Zoning Compliance Application

Town of Biltmore Forest

Name

Donna & Jeff Loftin

Property Address

14 Stuyvesant Road

Phone

(336) 202-5073

Email

donnaskigenloftin@gmail.com

Parcel ID/PIN Number

9646-88-4881

ZONING INFORMATION

Current Zoning

R-1

Lot Size

.79 acre

Proposed Roof Coverage Total

4,350 SF

Proposed Impervious Surface Coverage

8,353 SF

Front Yard Setback

60 feet (R-1 District)

Side Yard Setback

20 feet (R-1 District)

Rear Yard Setback

25 feet (R-1 District)

Building Height

29.5 FT

Description of the Proposed Project

Convert the original unusable garage space into a functioning garage with a living space above to match the existing roof lines of the house.

Estimated Start Date

6/16/2025

Estimated Completion Date

12/31/2025

Estimated Cost of Project

\$500,000.00

Supporting Documentation (Site Plan, Drawings, Other Information)

Loftin Landscape Design.pdf

Loftin Project Nesbitt Endorsement.png

Loftin Survey.pdf

Loftin Driveway.jpeg

Loftin House Front.jpeg

Loftin House Rear.jpeg

Loftin Garage.jpeg

Loftin Proposed Garage Addition.pdf

Loftin Samsel Renovation.pdf

Applicant Signature

Date

3/25/2025

Donna Loftin

VARIANCE APPLICATION

Town of Biltmore Forest

Name

Donna & Jeff Loftin

Address

14 Stuyvesant Road

Phone

(336) 202-5073

Email

donnaskigenloftin@gmail.com

Current Zoning/Use

Residential

Requested Use

Residential

APPLICATION REQUIREMENTS: An application to the Board of Adjustment for a variance must be submitted to the Town of Biltmore Forest Town Manager at least 21 days prior to the meeting at which the application will be considered. A pre-application meeting with Town staff is required prior to application submittal to the Board of Adjustment.

What would you like to do with your property?

Expand an unusable two car garage into a functioning three car garage with a living space above it (in order to match the roofline of the original structure).

What does the ordinance require?

The zoning ordinance requires the submittal requirements of Section 153.130, Schematic documents: site plan, floor plans, exterior elevations, dimensions, and exterior materials (see photos of existing home to match stucco, window colors, and roofing tiles). The ordinance requirements of 153.048 maximum impervious area of 12,244 sf for this project are well under at 8,353 sf; 153.07 dimensional requirements, minimum yard setback for R-1, as calculated by attached survey for building height: front yard 75ft existing home in compliance, rear yard 37 ft existing home in compliance, south side yard 32ft existing home in compliance, north side yard 32 ft existing home in compliance-variance requested to 20 ft; 153.043 roof area: maximum 3,879 sf, existing home 3,725 sf, variance requested to 4,350 sf (note: this is the same as a previously approved request of differing design). Please refer to the attached documents.

BOARD OF ADJUSTMENT: N.C.G.S. 160A-388(D) requires that the Board of Adjustment shall vary the provisions of the Zoning Ordinance only upon a showing of ALL the items below. The Board of Adjustment must follow strict procedure and all determinations must be decided by a concurring vote of four-fifths of the members of the Board. It is important to provide detailed supporting documentation for the Board of Adjustment to review. If necessary, additional sheets may be attached to this application.

REQUIRED FINDINGS: Please provide a thorough response to each.**Unnecessary hardship would result from the strict application of the ordinance.**

The current garage structure would continue to be unusable. Our automobiles would continue to remain parked in the driveway, thus not allowing for protection from severe weather and the elements, as well as not providing a secure entrance and exit from a locked garage. We were granted a variance for this same size expansion during our original remodel in or around 2015. We never proceeded with the original plan due a large imposition of the pervious area on our lot. We have adjusted the structure to be constructed within the existing driveway as to not impose on any green space, nor require any tree removal.

The hardship results from conditions that are peculiar to the property, such as location, size, or

topography.

The house was constructed in 1928. It is unable to accommodate modern vehicles due to the depth and size of the bays.

The hardship did not result from actions taken by the applicant or the property owner.

The current homeowners did not construct the original structure in 1928.

The requested variance is consistent with the spirit, purpose, and intent of the ordinance, such that public safety is secured, and substantial justice is achieved.

We have architectural plans to create an expansion fitting the exact French Normandy style of our house and appropriate to Biltmore Forest. We intend to use original materials to ensure a seamless transition to include brick, stucco, copper, and ludowici tile. Our cars will be secured and we will be safer entering and departing a locked garage. In addition, this area will be more visually pleasing from the street and neighbors' homes due to the remodeling of the current structure, lessening of the driveway surface, and the addition of extensive landscaping to be done; not to mention the cars will be housed inside the garage verses parked in the driveway. Our neighbor at 12 Stuyvesant Road supports the renovation and has no objections.

I hereby certify that all of the information set forth above is true and accurate to the best of my knowledge.

Signature

Date

3/25/2025

A handwritten signature in cursive script that reads "Donna Loftin".

Have you paid the \$300 variance application fee? Your permit application will not be reviewed until payment has been received. You can visit the link below to pay. Copy & paste the link in your browser.

I plan to pay in person or mail a check

Loftin-Skigen Renovation 14.41

14 Stuyvesant Rd, Biltmore Forest, NC, 28803

SAMSEL ARCHITECTS
P.A.
60 Biltmore Avenue
Asheville, NC 28801
P: 828.253.1124
F: 828.254.7316
www.samselarchitects.com

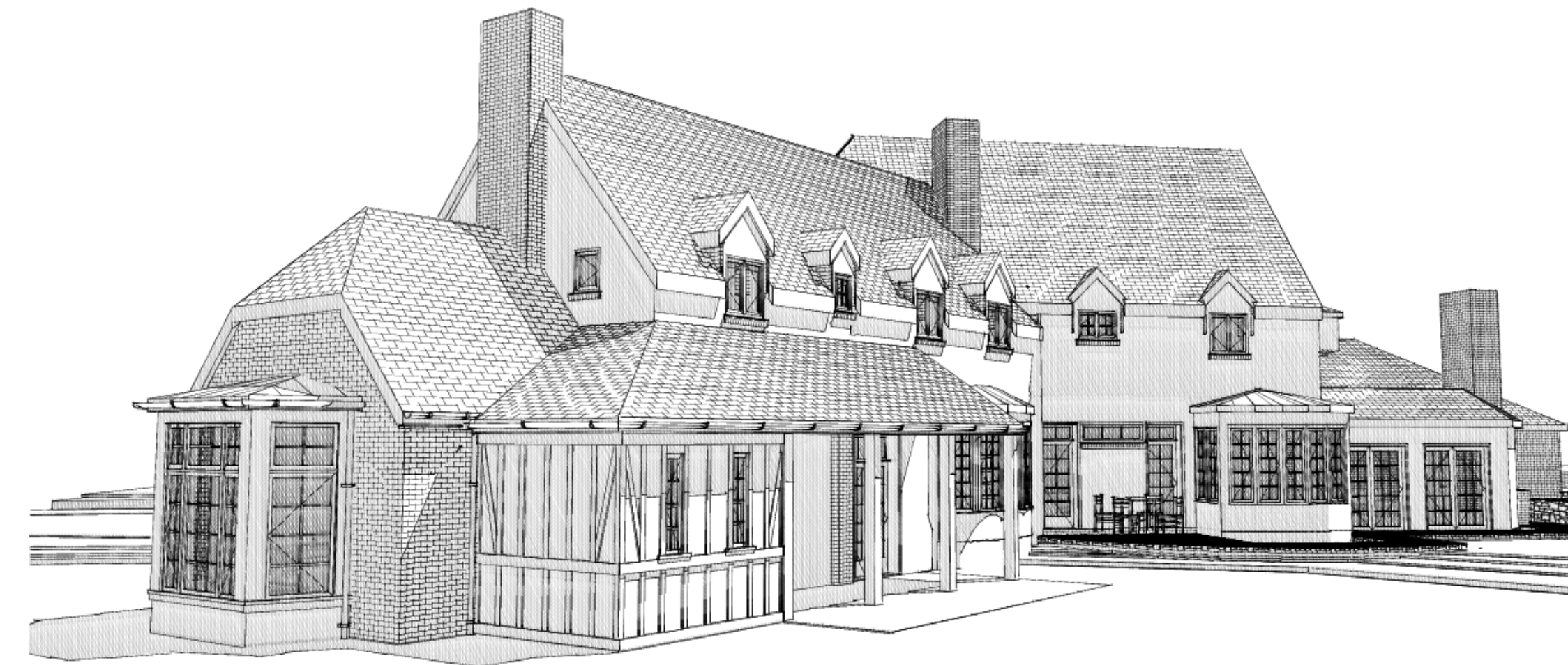
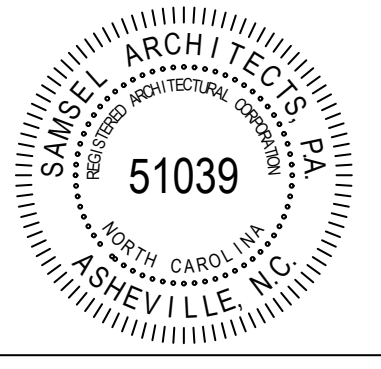
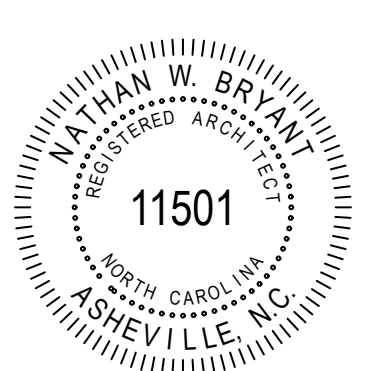

Master Bath Side Perspective

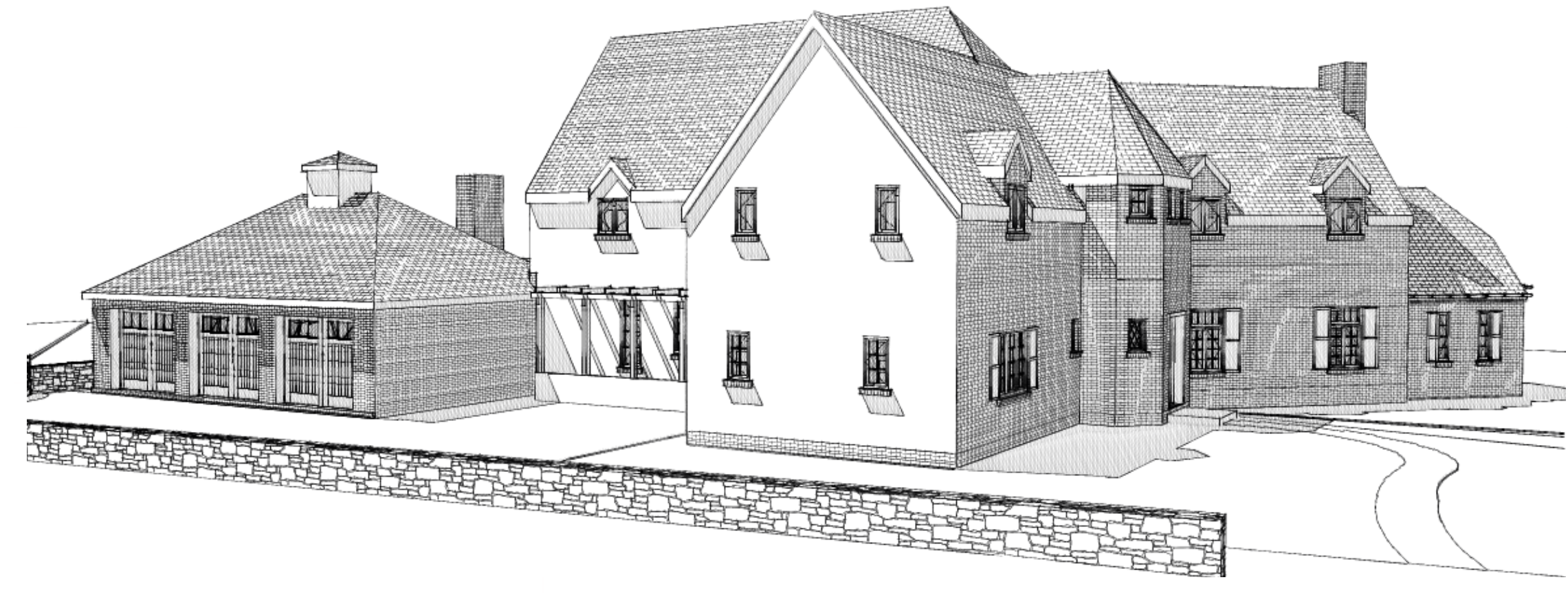

Garage Side Perspective

DRAWING INDEX				
SHEET	SHEET TITLE	DATE	DATE	DATE
A-000	COVER SHEET	04.16.15	05.01.15	
A-001	RADON & GENERAL NOTES		05.01.15	
L-101	SITE PLAN	04.16.15	05.01.15	
A-103	MAIN LEVEL FLOOR PLAN	04.16.15	05.01.15	
A-104	UPPER LEVEL FLOOR PLAN	04.16.15	05.01.15	
A-105	ROOF PLAN		05.01.15	
A-201	EXTERIOR ELEVATIONS	04.16.15	05.01.15	
A-202	EXTERIOR ELEVATIONS	04.16.15	05.01.15	
A-203	EXTERIOR ELEVATIONS	04.16.15	05.01.15	
A-301	BUILDING SECTIONS	04.16.15	05.01.15	
A-302	BUILDING SECTIONS	04.16.15	05.01.15	
A-501	INTERIOR ELEVATIONS		05.01.15	
A-502	INTERIOR ELEVATIONS		05.01.15	
E-100	ELECTRICAL NOTES & LEGEND		05.01.15	
E-102	MAIN LEVEL ELECTRICAL PLAN		05.01.15	
E-103	UPPER LEVEL ELECTRICAL PLAN		05.01.15	
D-101	MAIN LEVEL DEMOLITION PLAN	04.16.15	05.01.15	
D-102	UPPER LEVEL DEMOLITION PLAN	04.16.15	05.01.15	

ABBREVIATIONS

AC Acoustic	FO Face of	PLAM Plastic Laminate
ACT Acoustic Ceiling Tile	FOC Face of Concrete	PLBG Plumbing
ADJ Access Door	FOM Face of Masonry	PLY Plywood
ADJ Adjacent	FOS Face of Stud(s)	POLY Polyethylene
AFF Above Finished Floor	FOW Face of Wall	PNBD Panelboard
AHU Air Handling Unit	FP Fire Protection	PR Pair
ALT Alternate	FRGWB Fire Rated Gypsum Wallboard	PSF Pounds per Square Foot
ALUM Aluminum	FRP Fiber Reinforced Panel	PSI Pounds per Square Inch
AP Access Panel	FT Foot/Foot	PSL Parallel Strand Lumber
BEV Beveled	FTG Footing	PT Pressure Treated
BLDG Building	FUT Future	PTD Painted
BO Bottom of	GA Gage	PVC Polyvinyl Chloride
BOW Bottom of Wall	GLV Galvanized	QT Quarry Tile
BLKG Blocking	GC General Contractor	R Riser
BRD Board	GL Glass/Glazing	RAD Radius
BRG Bearing	GWB Gypsum Wallboard	REG Register
CAB Cabinet	H Height/Height	REQ'D Required
CER Ceramic	HD HT Head Height	RET Return
CJ Control Joint	HDWD Hardwood	REV Revised/Revision(s)
CL Closet	HDWR Hardware	RO Rough Opening
CLG Ceiling	HM Hollow Metal	SAFB Sound Attenuating Fiberglass
CLR Clear(ance)	HORIZ Horizontal	SAN Sanitary
CMU Concrete Masonry Unit	HC Handicapped	SF Square Foot/Feet
COL Column	HVAC Heating, Ventilation & Air Conditioning	SIM Similar
CONC Concrete	INSUL Insulation	SLNT Sealant
CONT Continuous	INT Interior	SPF Spruce/Pine/Fir
DEMO Demolish/Demolition	KD Kiln Dried	SIS Stainless Steel
DET Detail	LAV Lavatory	STD Standard
DF Drinking Foundation	LCC Lead Coated Copper	SUSP (Suspend(ed))
DIM Dimension	LVL Laminated Veneer Lumber	SYP Southern Yellow Pine
DISP Dispenser	LVR Louver	T Tread
DMT Demountable	MAX Maximum	T&G Tongue & Groove
DN Down	MDF Medium Density Fiberboard	TELE Telephone
DNSP Downspout	MDO Medium Density Overlay	THRU Through
DWG Drawing(s)	MECH Mechanical	TO Top of
DWR Drawer	MEMB Membrane	TOB Top of Beam
EA Each	MFR Manufacturer	TOD Top of Decking
EJ Expansion Joint	MIN Minimum	TOF Top of Footing
EL Elevation	MISC Miscellaneous	TOPL Top of Plate
ELEC Electric(al)	MO Masonry Opening	TOS Top of Slab
ELEV Elevator	MLDG Moulding	TOSTL Top of Steel
EQ Equal	MR Moisture Resistant	TOW Top of Wall
EQUIP Equipment	MRGWB Moisture Resistant Gypsum	TRTD Pressure Treated Lumber
EXIST Existing	Wallboard	TYP Typical
EXP Expansion	MTD Mounted	UL Underwriters Laboratory
EXT Exterior	MTL Metal	UNF Unfinished
FD Floor Drain	NIC Not In Contact	UNO Unless Noted Otherwise
FEC Fire Extinguisher Cabinet	NOM Nominal	VAR Varies
FF Finish Face	NTS Not to Scale	VB Vapor Barrier
FG Fixed Glass	OC On Center(s)	VCT Vinyl Composition Tile
FIN Finished	OD Outside Diameter	VERT Vertical
FIN FL Finished Floor	OPNG Opening	W/ With
FL Floor	OSB Oriented Strandboard	W/O Without
FLG Flooring	OPP Opposite	WP Waterproofing
FLSH Flashing	PAN Panel	WR Water Resistant
FNDN Foundation	PARTN Partition	WWF Welded Wire Fabric
	PERF Perforated	

PROJECT TEAM

ARCHITECT:
Samsel Architects, P.A.
60 Biltmore Avenue
Asheville, NC 28801
P: 828.253.1124
F: 828.254.7316

SQUARE FOOTAGE:

EXISTING AREA:
Main Level Heated: 2,600 sf
Main Level Unheated: 756 sf
(patios, porches, garage)
Upper Level Heated: 2,182 sf

TOTAL EXISTING AREA: 5,538 sf

FINISHED AREA WITH ADDITION:
Main Level Heated: 2,956 sf
Main Level Unheated: 1,568 sf
(patios, porches, garage)
Upper Level Heated: 2,182 sf

TOTAL FINISHED AREA: 6,706 sf
(heated and unheated)

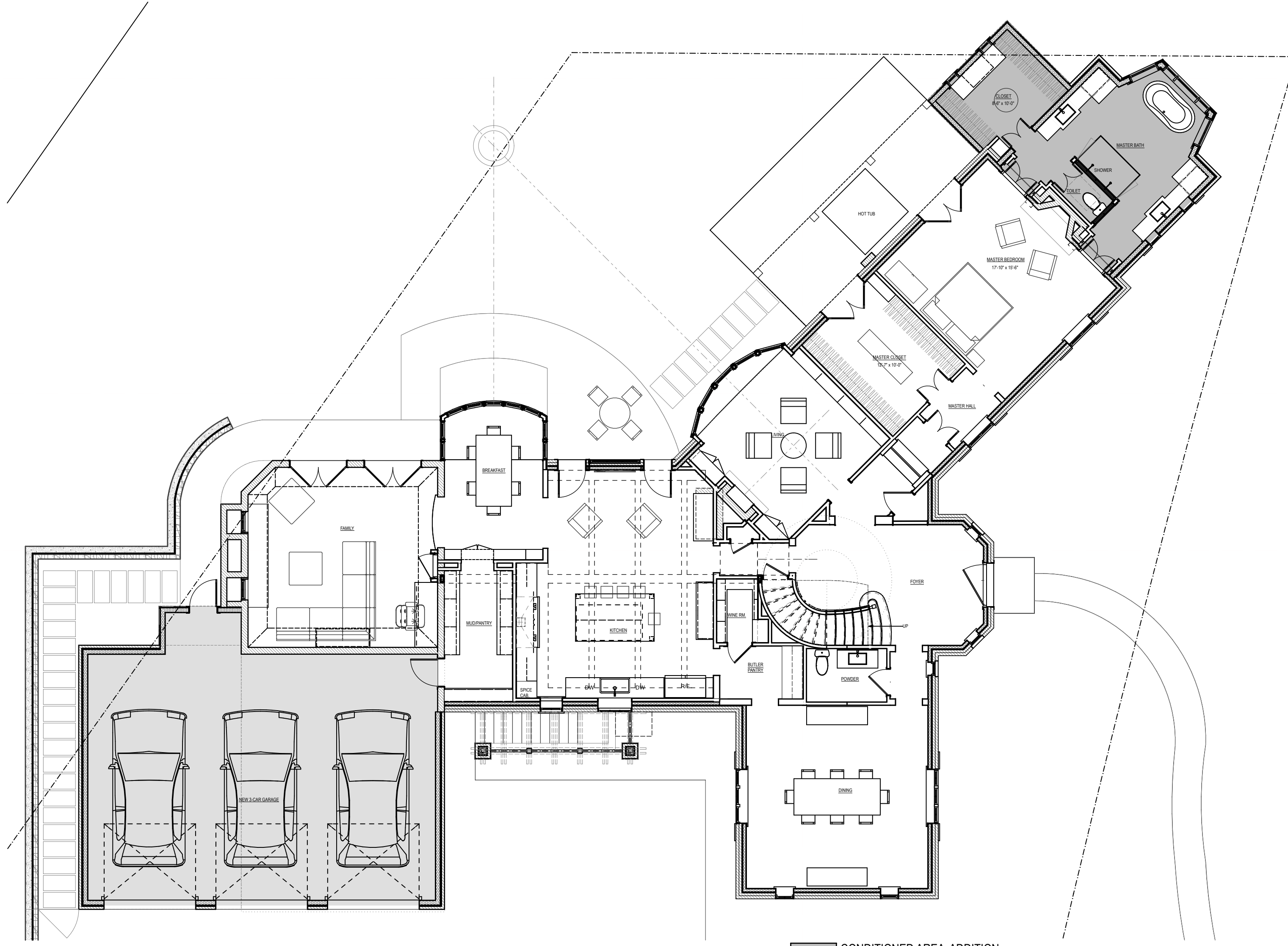

ADDITION PLAN
SCALE: 1/8" = 1'-0"

CONDITIONED AREA ADDITION
UNCONDITIONED AREA ADDITION

PROJECT:
Loftin-Skigen Renovation
14 Stuyvesant Rd
Biltmore Forest, NC 28803

SHEET TITLE:
COVER SHEET

DATE:	DESCRIPTION:
02.23.15	BOARD OF ADJUSTMENT
03.13.15	OWNER REVIEW
04.03.15	OWNER REVIEW
04.16.15	OWNER REVIEW
04.24.15	OWNER REVIEW
05.01.15	PERMIT SET

PROJECT #:
14.41
DRAWN BY: DKT
CHECKED BY: JS

SHEET #:
A-000

COPYRIGHT 2014
SAMSEL ARCHITECTS, P.A.

RADON NOTES

- INSTALL A COMPLETE, PASSIVE SUB-SLAB OR SUB-MEMBRANE SOIL DEPRESSURIZATION SYSTEM TO BE FULLY FUNCTIONING AS SOON AS CONSTRUCTION IS COMPLETED. IN A PASSIVE SYSTEM, THE VENT PIPE IS ROUTED THROUGH WARM SPACE AND THE STACK EFFECT CREATES A NATURAL DRAFT IN THE PIPE. SEE DETAILS.
- PERFORM TESTING AFTER OCCUPANCY AND ACTIVATE THE PASSIVE SYSTEM IF POST-OCCUPANCY TESTING REVEALS RADON LEVELS AT OR ABOVE 4pCi/L.
- ALL CONCRETE SLABS THAT COME IN CONTACT WITH THE GROUND SHALL BE LAID OVER A GAS PERMEABLE MATERIAL MADE UP OF EITHER A MINIMUM 4" THICK UNIFORM LAYER OF CLEAN AGGREGATE, OR A MINIMUM 4" THICK UNIFORM LAYER OF SAND, OVERLAIN BY A LAYER OR STRIPS OF MANUFACTURED MATTING DESIGNED TO ALLOW THE LATERAL FLOW OF SOIL GASES. INSTALL 4" PVC TRANSFER PIPES WHERE GAS PERMEABLE MATERIAL IS NOT CONTINUOUS, LEAVING NO AREAS BENEATH THE SLAB FROM WHICH SOIL GASES CANNOT FLOW FREELY TO VENT PIPE TERMINATION.
- FILL OR CLOSE ALL OPENINGS, GAPS AND JOINTS IN FLOOR AND WALL ASSEMBLIES IN CONTACT WITH SOIL OR GAPS AROUND PIPES, TOILETS, BATH TUBS OR DRAINS PENETRATING THESE ASSEMBLIES WITH MATERIALS THAT PROVIDE A PERMANENT AIR-TIGHT SEAL. SEAL LARGE OPENINGS WITH NON-SHRINK MORTAR, GROUTS OR EXPANDING FOAM MATERIALS AND SMALLER GAPS WITH AN ELASTOMERIC JOINT SEALANT, AS DEFINED IN ASTM C920-87.
- FILL OR CLOSE ALL OPENINGS, GAPS AND JOINTS IN FLOOR AND WALL ASSEMBLIES BETWEEN CRAWL SPACES AND CONDITIONED SPACE OR GAPS AROUND PIPES, TOILETS, BATH TUBS OR DRAINS PENETRATING THESE ASSEMBLIES.
- INSTALL A MINIMUM 6-MIL POLYETHYLENE SHEETING OR EQUIVALENT SOIL-GAS RETARDER MEMBRANE OVER GAS PERMEABLE MATERIAL UNDER CONCRETE SLABS AND IN CRAWL SPACES. OVERLAP SEAMS 12" MINIMUM UNDER CONCRETE SLABS. IN CRAWL SPACES, OVERLAP AND SEAL ADJOINING SHEETS AND SEAL MEMBRANE AGAINST WALL AND AROUND PENETRATIONS.
- VENT PIPES ARE 4" PVC OR EQUIVALENT. 3" PIPE MAY BE USED WHERE 4" PIPE WILL NOT FIT IN STRUCTURE (I.E. 2x4 WALLS). INSTALL VENT PIPES SO AS TO BE CONTINUOUS FROM INTAKE BENEATH THE SLAB OR SOIL-GAS RETARDER MEMBRANE THROUGH THE STRUCTURE AND TERMINATE 12" MINIMUM ABOVE THE FINISHED ROOF AND 10'-0" MINIMUM FROM OPENINGS INTO CONDITIONED SPACE. VENT PIPES SHALL BE INSTALLED SO THAT ANY RAINWATER OR CONDENSATION DRAINS DOWNWARD INTO THE GROUND BENEATH THE SLAB OR SOIL-GAS RETARDER MEMBRANE.
- TERMINATE VENT PIPE BENEATH THE SLAB OR SOIL-GAS RETARDER MEMBRANE USING A 4" PVC "T" FITTING OR EQUIVALENT IN CRAWL SPACES. INSTALL A LENGTH OF 4" DIAMETER PERFORATED DRAIN TILE HORIZONTALLY BENEATH THE SHEETING AND CONNECT TO THE "T" FITTING WITH THE VERTICAL STANDPIPE THROUGH THE SOIL-GAS-RETARDER MEMBRANE. INSTALL DRAIN TILE IN A SHALLOW TRENCH AND BACKFILL WITH GRAVEL. PLACE PARALLEL TO THE LONG DIMENSION OF THE HOUSE AND EXTEND NO CLOSER THAN 6'-0" TO THE FOUNDATION WALL.
- INSTALL JUNCTION BOX IN ATTIC FOR FUTURE INSTALLATION OF VENT FAN.
- INSTALL JUNCTION BOX IN AN ACCESSIBLE LOCATION WITHIN THE BUILDING FOR FUTURE INSTALLATION OF WARNING DEVICE. CONFIRM LOCATION WITH ARCHITECT PRIOR TO INSTALLATION.
- CIRCUITS FOR FUTURE INSTALLATION OF VENT FAN AND WARNING DEVICE TO BE A MINIMUM 15 AMP, 115 VOLT.
- IF POST-OCCUPANCY TESTING REQUIRES THE SYSTEM TO BE ACTIVATED, INSTALL AN IN-LINE VENT FAN IN THE VERTICAL RUN OF THE VENT PIPE. THE SIZE AND AIR MOVEMENT CAPACITY OF THE VENT FAN SHALL BE SUFFICIENT TO CREATE AND MAINTAIN A PRESSURE FIELD BENEATH THE SLAB OR CRAWL SPACE MEMBRANE THAT IS LOWER THEN THE PRESSURE ABOVE THE SLAB OR MEMBRANE. ALL POSITIVELY PRESSURED PORTIONS OF THE VENT PIPE AND FAN SHALL BE LOCATED OUTSIDE THE HABITABLE SPACE OF THE BUILDING.
- SYSTEM FAILURE DEVICE: PROVIDE A VISIBLE OR AUDIBLE WARNING SYSTEM TO ALERT THE BUILDING OCCUPANT IF THERE IS A LOSS OF PRESSURE OR AIR FLOW IN THE VENT PIPE OF AN ACTIVATED SYSTEM.

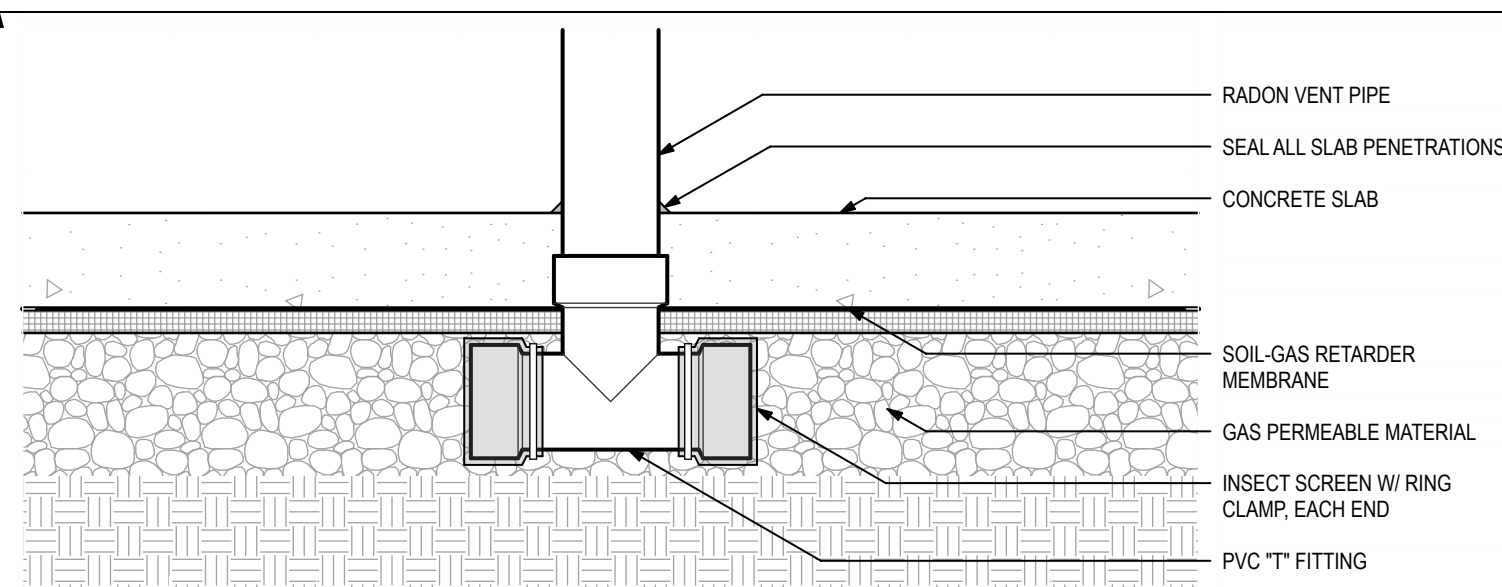

RADON VENT AT CONCRETE SLAB

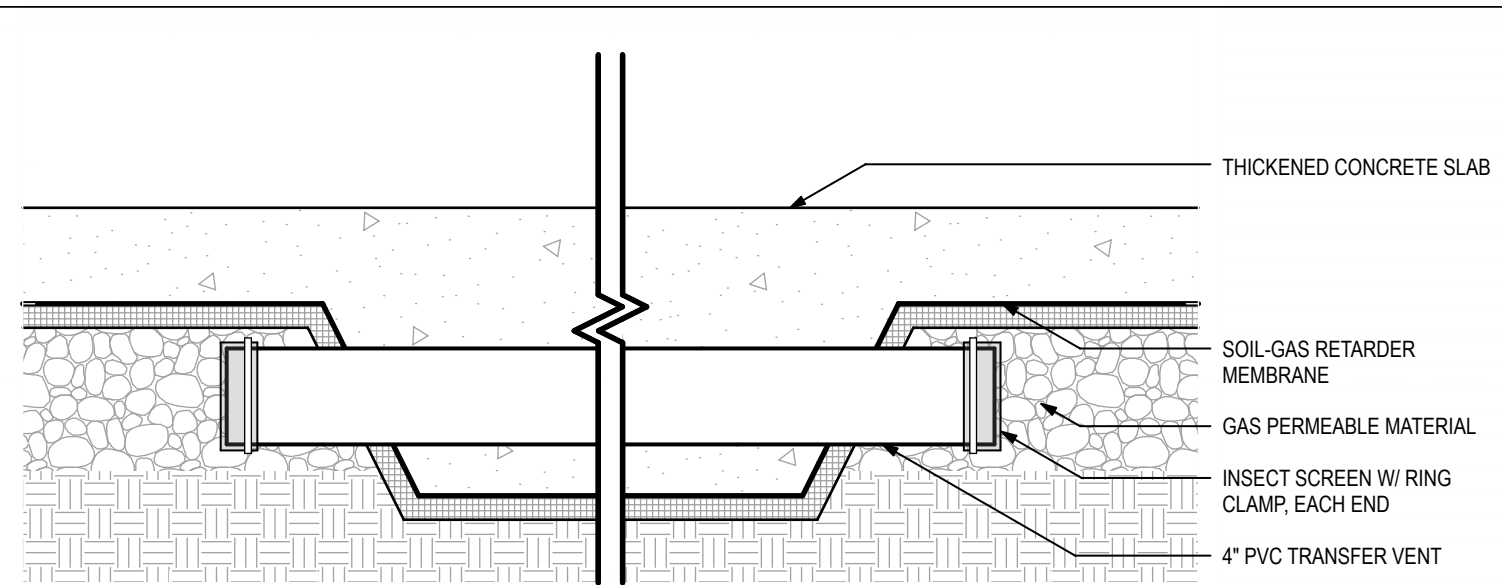

RADON TRANSFER VENT

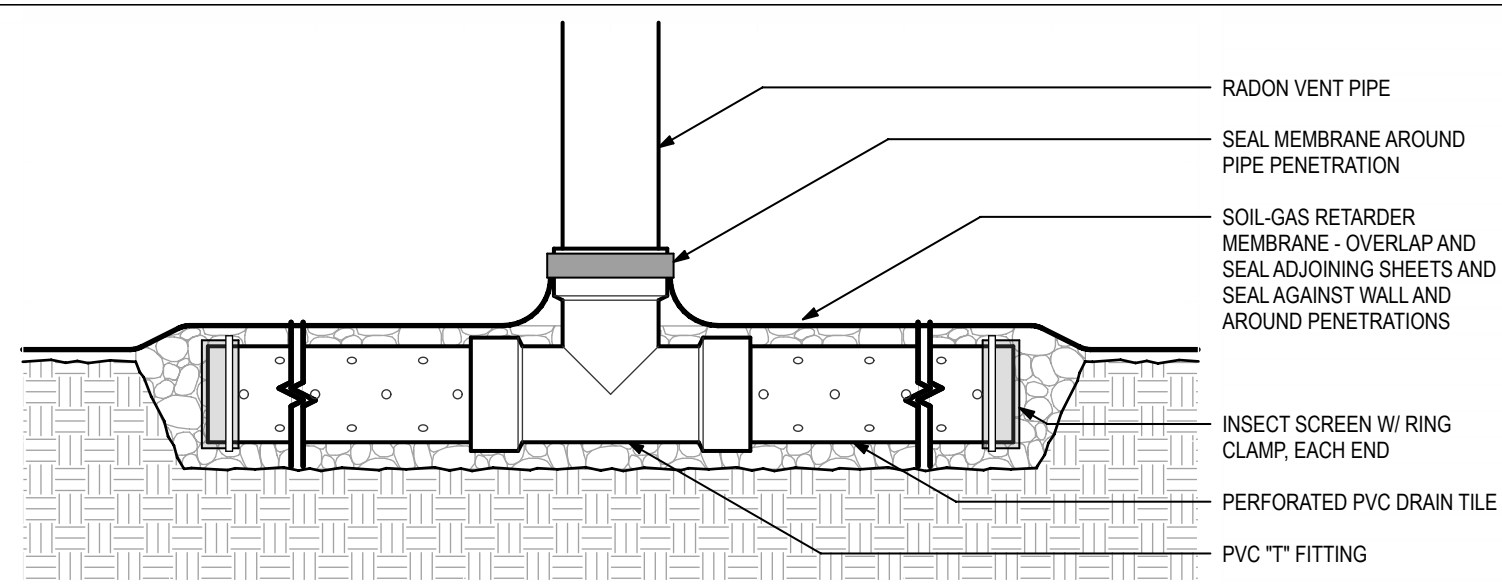

RADON VENT AT CRAWLSPACE

CREATION DATE: 6/17/15

BUILDING ENVELOPE NOTES

- THE BUILDING ENVELOPE CONSISTS OF THE COMPONENTS OF THE BUILDING THAT ENCLOSE CONDITIONED SPACE AND ARE CAPABLE OF TRANSFERRING THERMAL ENERGY SUCH AS ROOFS, CEILINGS, WALLS, FLOORS AND FOUNDATIONS.
- INSULATE ALL FOUNDATION WALLS AND SLABS PER DRAWINGS AND SPECIFICATIONS.
- SEAL ALL PENETRATIONS IN CONCRETE SLABS ON GRADE.
- COVER AND SEAL ALL HOLES, PENETRATIONS, CRACKS AND GAPS IN FLOORS, WALLS, ROOFS, CEILINGS, AND ANY OTHER BUILDING ASSEMBLIES SEPARATING CONDITIONED AND UNCONDITIONED SPACE, INCLUDING ATTICS, GARAGES AND CRAWL SPACES. SPECIFIC AREAS TO CONSIDER INCLUDE:
 - DUCT AND FLUE SHAFTS AND MECHANICAL CHASES
 - PLUMBING AND PIPING PENETRATIONS
 - PENETRATIONS FOR ELECTRICAL WIRING
 - PENETRATIONS FOR BATH, KITCHEN AND AN OTHER EXHAUST FANS AND DUCTS
- USE CONTINUOUS SEALANT, ADHESIVE, OR GASKETS AT:
 - FOUNDATION WALL SILL PLATES
 - TOP AND BOTTOM PLATES OF FRAMED WALLS SEPARATING CONDITIONED AND UNCONDITIONED SPACE
 - RIM JOISTS/ BAND JOISTS IN FLOOR ASSEMBLIES SEPARATING CONDITIONED AND UNCONDITIONED SPACE
 - ALL WINDOWS AND DOORS BETWEEN CONDITIONED AND UNCONDITIONED SPACE
 - FIREPLACE AND CHIMNEY/ FLUE ENCLOSURES
 - UTILITY CHASES AND VENT STACK PENETRATIONS
 - ATTIC ACCESS HATCHES/ WHOLE HOUSE FANS
- INSULATE ALL HEADERS IN WALLS SEPARATING CONDITIONED AND UNCONDITIONED SPACE. INSTALL INSULATION ON CONDITIONED SIDE OF WALL U.N.O.
- PROVIDE ADDITIONAL INSULATION AS PERMITTED BY ADVANCED FRAMING TECHNIQUES AT WALL CORNERS AND INTERSECTIONS.
- INSTALL INSULATION IN FLOORS BETWEEN CONDITIONED AND UNCONDITIONED SPACE TO MAINTAIN FULL CONTACT WITH SUBFLOOR ABOVE INCLUDING NECESSARY SUPPORTS.
- PROVIDE AIR BARRIER FULLY ALIGNED WITH RESNET GRADE 1 INSULATION AT ENTIRE BUILDING ENVELOPE. SPECIFIC AREAS TO CONSIDER INCLUDE:
 - GARAGE BAND, JOIST AT BAYS ADJOINING CONDITIONED SPACE
 - WALLS OR OTHER BUILDING ASSEMBLIES SURROUNDING SHOWERS AND BATH TUBS
 - WALLS OR OTHER BUILDING ASSEMBLIES SURROUNDING FIREPLACES
 - INSULATED ATTIC SLOPES/ WALLS
 - ATTIC KNEE WALLS
 - SKYLIGHT SHAFT WALLS
 - WALLS OR OTHER BUILDING ASSEMBLIES ADJOINING PORCHES
 - WALLS OR OTHER BUILDING ASSEMBLIES SURROUNDING STAIRCASES
 - DOUBLE WALLS
- INSTALL WATER RESISTIVE BARRIER ACCORDING TO MANUFACTURERS INSTRUCTIONS AND IN A MANNER SUCH THAT MOISTURE DRAINS CONTINUOUSLY ALONG ITS SURFACE UNTIL IT CAN ESCAPE THE WALL ASSEMBLY TO THE EXTERIOR. INSTALL FROM BOTTOM OF WALL TO TOP, OVERLAPPING THE PREVIOUS LAYER, AS CONTINUOUSLY AS POSSIBLE. TAPE ALL SEAMS AND JOINTS AND SEAL ALL PENETRATIONS. INSTALL WATER RESISTIVE BARRIER OVER FLASHING SO THAT MOISTURE IS DIRECTED TO THE EXTERIOR AT ALL FLASHING LOCATIONS.
- ALL FENESTRATION IN THE BUILDING ENVELOPE SHALL MEET OR EXCEED 2009 IECC REQUIREMENTS
- SEAL ALL ROUGH OPENINGS AROUND FENESTRATION IN BUILDING ENVELOPE.
- ALL DOORS, HATCHES AND ACCESS PANELS BETWEEN CONDITIONED AND UNCONDITIONED SPACE, INCLUDING ATTICS, GARAGES, BASEMENTS AND CRAWL SPACES, MUST BE GASKETED OR OTHERWISE MADE SUBSTANTIALLY AIRTIGHT.
- USE AIRTIGHT, IC RATED RECESSED LIGHT FIXTURES IN INSULATED ROOFS AND CEILINGS. SEE ELECTRICAL DRAWINGS AND SPECIFICATIONS.
- USE GASKETED ELECTRICAL BOXES IN EXTERIOR WALLS AND INSULATED ROOFS/ CEILINGS FOR AIRTIGHT INTERIOR FINISH INSTALLATION.
- TAPE OR SEAL ALL JOINTS IN CONTINUOUS RIGID INSULATION.
- BLOWER DOOR TESTING TO BE PERFORMED AFTER FINISHES AND FIXTURES ARE INSTALLED TO MEASURE AIR INFILTRATION, RESULTING IN A MAXIMUM OF 3 AIR CHANGES PER HOUR AT 50 PASCALS OF PRESSURE.

SITE NOTES

- CERTIFICATION OF CUT AND FILL SLOPES IS THE RESPONSIBILITY OF THE OWNER/ DEVELOPER, TO BE MADE BY A GEOTECHNICAL ENGINEER LICENSED TO PRACTICE IN THE STATE, DISTRICT OR LOCALE HAVING JURISDICTION.
- CONSTRUCT CUT AND FILL SLOPES AND EMBANKMENTS IN ACCORDANCE WITH NCDOT STANDARD SPECIFICATION SECTION 235 OR THE GEOTECHNICAL (SOILS) REPORT RECOMMENDATIONS, WHICHEVER IS MORE RESTRICTIVE. AT A MINIMUM, PLACE ALL FILL SLOPES SHALL IN 10 INCH MAXIMUM LIFTS, COMPACTED TO NOT LESS THAN 95 PERCENT DENSITY (STANDARD PROCTOR). CONTRACTOR TO ARRANGE FOR INDEPENDENT COMPACTION TESTING TO BE PAID FOR BY THE OWNER/DEVELOPER.
- DO NOT USE STRAW MULCH AND TALL FESCUE IN RIPARIAN AREAS.
- IF CONCRETE IS USED NEAR SURFACE WATERS (EG. AT HEADWALLS), MAINTAIN A DRY WORK AREA MAINTAINED TO PREVENT DIRECT CONTACT BETWEEN CURING CONCRETE AND STREAM WATER. DO NOT DISCHARGE WATER THAT INADVERTENTLY CONTACTS LIVE CONCRETE TO SURFACE WATERS DUE TO THE POTENTIAL FOR WATER CHEMISTRY CHANGE AND FISH KILLS.
- DO NOT EXCAVATE ROCK, SAND OR OTHER MATERIALS FROM STREAM CHANNELS EXCEPT IN THE IMMEDIATE VICINITY OF CULVERT LOCATIONS. DO NOT MODIFY THE NATURAL DIMENSION, PATTERN, OR PROFILE OF THE CHANNEL UPSTREAM OR DOWNSTREAM OF THE CULVERT.
- USE SANDBAGS, FLEXIBLE PIPE, OR OTHER DIVERSION STRUCTURES TO AVOID EXCAVATING IN FLOWING WATER. REMOVE ALL MATERIALS USED FOR FLOW DIVERSION FROM THE STREAM BED AFTER COMPLETING THE CONSTRUCTION WORK. LINE ANY DIVERSION CHANNELS WITH FILTER FABRIC AND/OR ROCK.
- REMOVE ALL ROCK AND OTHER MATERIALS PLACED TEMPORARILY IN STREAMS FOR FORDS AND RESTORE THE STREAM CHANNELS TO PRE-EXISTING CONDITIONS AFTER THE FORDS ARE NO LONGER NEEDED.
- PRESERVE RIPARIAN VEGETATION, ESPECIALLY TREES AND SHRUBS, AS MUCH AS POSSIBLE. NATIVE WOODY VEGETATION REMOVED DURING CONSTRUCTION (EG. RHODODENDRON, DOG HOBBLE, SILKY DOGWOOD, SYCAMORE, RIVER BIRCH, RED MAPLE) SHOULD BE REESTABLISHED DOWNSTREAM OF CULVERTS AND FORDS TO PROVIDE BANK STABILITY AND SHADING. RE-USE NATIVE PLANTS PERMANENTLY REMOVED FROM DISTURBED AREAS WHERE POSSIBLE.
- INSPECT AND MAINTAIN ALL MECHANIZED EQUIPMENT OPERATED NEAR SURFACE WATERS REGULARLY TO PREVENT CONTAMINATION OF STREAM WATERS FROM FUELS, LUBRICANTS, HYDRAULIC FLUIDS OR OTHER TOXIC MATERIALS.
- DO NOT DISCHARGE HYDROSEED MIXTURES OR WASH OUT HYDROSEEDERS OR OTHER EQUIPMENT IN OR ADJACENT TO SURFACE WATERS.
- CONTRACTOR IS REQUIRED TO PROVIDE EVIDENCE OF VALID GRADING PERMITS FOR ANY OFF-SITE BORROW OR WASTE AREAS.
- STRIP TOPSOIL AND STOCKPILE ONSITE. UPON COMPLETION OF ROUGH GRADING, PLANTING AREAS (I.E. THOSE NOT TO BE USED FOR BUILDING OR VEHICULAR USE) TO RECEIVE A 4 TO 6 INCH COMPACTED LAYER OF TOPSOIL.
- SLOPE FINISHED GRADE A MINIMUM OF 1/2" VERTICAL PER 1'-0" HORIZONTAL FOR A DISTANCE OF 10'-0" AWAY FROM THE STRUCTURE AND COMPACT TO PREVENT SETTLING.
- WALL GRADES NOTED (TW/BW) ARE THE ELEVATION AT ADJACENT FINISHED GRADE AND DO NOT REFLECT THE PORTION OF WALL THAT EXTENDS BELOW GRADE OR PORTION OF THE WALL THAT PROTRUDES ABOVE GRADE. EXTEND TOP OF WALL EXTEND AT LEAST ONE FULL SEGMENTAL BLOCK HEIGHT (WHERE APPLICABLE) ABOVE FINISHED GRADE AND STEP AS NEEDED TO CONFORM TO THE ADJACENT GRADE. CONFIRM STEPPING W/ ARCHITECT. THE AMOUNT OF WALL TO EXTEND BELOW GRADE SHALL BE DETERMINED BY THE WALL MANUFACTURER/ DESIGNER.
- RETAINING WALLS GREATER THAN 48" IN HEIGHT TO BE DESIGNED BY AN ENGINEER LICENSED TO PRACTICE IN THE STATE, DISTRICT OR LOCALE HAVING JURISDICTION.
- STABILIZE ALL SLOPES IN EXCESS OF 3:1.
- STABILIZE ALL DRAINAGE SWALES ADJACENT TO PROPOSED DRIVEWAY(S).
- GENERAL CONTRACTOR TO LOCATE ALL UTILITY SERVICES (I.E. WATER, GAS, ELECTRIC, TELEPHONE, CABLE TV/ DATA) AND COORDINATE THE EXTENSIONS TO THE BUILDING WITH THE APPROPRIATE INSTALLATION. LOCATE ALL CONNECTIONS, METERS, CLEAN OUTS, ETC. AWAY FROM ANY PROMINENT VIEW, APPROACH OR WALKWAY.
- GENERAL CONTRACTOR TO COORDINATE FINISH TOPOGRAPHIC GRADING, PAVING, WALKWAYS, PATIOS, DRIVEWAYS, ETC. AS REQUIRED FOR POSITIVE DRAINAGE AWAY FROM THE BUILDING (MIN. 1/4" VERT. PER 1'-0" HOR. FOR 10'-0" DISTANCE AWAY FROM STRUCTURE).
- GENERAL CONTRACTOR TO VERIFY EXISTING TOPOGRAPHIC GRADE LEVELS, LOCATION OF TREES, AND THE PROPOSED BUILDING LOCATION. GENERAL CONTRACTOR TO COMMUNICATE TO OWNER AND ARCHITECT ANY RECOMMENDED CHANGES BEFORE THE START OF ANY WORK.

PLUMBING NOTES

- PLUMBING SUBCONTRACTOR IS RESPONSIBLE FOR ADHERING TO ALL APPLICABLE CODES AND SAFETY REQUIREMENTS.
- PROVIDE GAS SERVICE TO ALL WATER HEATERS, HVAC EQUIPMENT, FIREPLACES, WOOD STOVES, COOKTOPS, GRILLS AND ANY OTHER APPLIANCES OR EQUIPMENT AS REQUIRED.
- IF WALL PLATES, JOISTS OR OTHER STRUCTURAL FRAMING MEMBERS ARE CUT DURING INSTALLATION OF PLUMBING FIXTURES OR EQUIPMENT, PROVIDE BRACING TO THE FRAMING BACK TOGETHER AS REQUIRED. COORDINATE WITH GENERAL CONTRACTOR.
- PROVIDE METAL PANS AND AUXILIARY OVERFLOW DRAIN TO TERMINATE OUTSIDE FOR WATER HEATERS LOCATED IN ATTICS.
- PROVIDE FLOOR DRAINS AS SHOWN IN THE DRAWINGS AND IN SEALED CRAWL SPACES AND MECHANICAL ROOMS.
- ALL VENT/ FLUE STACKS TO BE COMBINED TOGETHER IN THE ATTIC TO MINIMIZE ROOF PENETRATIONS WHERE POSSIBLE. LOCATE PENETRATIONS AWAY FROM PROMINENT VIEW(S) OF THE HOUSE. PRIME AND PAINT ALL VENT STACKS AND FLUES TO MATCH THE ROOF COLOR UNLESS NOTED OTHERWISE.
- PLUMBING CONTRACTOR SHALL BE RESPONSIBLE FOR INSULATING ALL EXPOSED PIPES.

HVAC NOTES

- MECHANICAL CONTRACTOR IS RESPONSIBLE FOR ADHERING TO ALL APPLICABLE CODES AND SAFETY REQUIREMENTS.
- IF NOT INCLUDED IN THE CONSTRUCTION DOCUMENTS, ALL HEATING AND COOLING EQUIPMENT MUST BE SIZED AND SELECTED USING THE LATEST EDITIONS OF ACCA MANUALS J AND S, ASHRAE HANDBOOK OF FUNDAMENTALS OR AN EQUIVALENT COMPUTATION PROCEDURE.
- IF NOT INCLUDED IN THE CONSTRUCTION DOCUMENTS, AIR DISTRIBUTION SYSTEM(S) TO BE DESIGNED USING THE LATEST EDITION OF ACCA MANUAL D OR EQUIVALENT COMPUTATION PROCEDURE.
- SEAL ALL DUCTWORK CONNECTIONS, INCLUDING RETURN DUCTS AND TRUNK CONNECTIONS TO AIR HANDLER, BOOT FLANGES, ETC. WITH MASTIC.
- ALL DUCTWORK TO BE INSULATED.
- PAINT INSIDE OF RETURN DUCT BOOT REGISTERS FLAT BACK.
- CENTER REGISTERS ON DOORS AND WINDOWS AND/OR LOCATE SO FLANGE EDGE IS 4" OFF FINISHED WALL(S).
- HVAC CONTRACTOR TO PROVIDE AND INSTALL DUCTWORK FOR ALL EXHAUST FANS, KITCHEN VENTILATION HOODS AND DRYER VENTS.
- ALL VENT/ FLUE STACKS TO BE COMBINED TOGETHER IN THE ATTIC TO MINIMIZE ROOF PENETRATIONS WHERE POSSIBLE. LOCATE PENETRATIONS AWAY FROM PROMINENT VIEW(S) OF THE HOUSE. PRIME AND PAINT ALL VENT STACKS AND FLUES TO MATCH THE ROOF COLOR U.N.O.

GENERAL NOTES

- CONSTRUCTION TO BE IN ACCORDANCE WITH ALL APPLICABLE CODES, REGULATIONS, AND STANDARDS AS INTERPRETED BY THE AUTHORITY HAVING JURISDICTION.
- ALL NEW CONSTRUCTION TO BE PLUMB, LEVEL, AND SQUARE UNLESS NOTED OTHERWISE.
- SUB-CONTRACTORS ARE RESPONSIBLE FOR VERIFYING ALL CONDITIONS IN THE FIELD PRIOR TO ORDERING OR FABRICATING EQUIPMENT, ASSEMBLIES, ETC. FOR USE WITH THIS JOB.
- DO NOT INSTALL BUILDING MATERIALS WITH VISIBLE SIGNS OF WATER DAMAGE OR MOLD.
- DO NOT ENCLOSE BUILDING ASSEMBLIES IF EITHER THE FRAMING MEMBERS OR INSULATION PRODUCTS HAVE HIGH MOISTURE CONTENT.

SLAB NOTES

- PROVIDE CAPILLARY BREAK MATERIAL BENEATH ALL SLABS UNLESS NOTED OTHERWISE.
- SEAL ALL INTERIOR SLAB PENETRATIONS.
- SLOPE PATIO, WALKWAY AND DRIVEWAY SLABS A MINIMUM OF 1/4" (1/4" TYP.) VERTICAL PER 1'-0" HORIZONTAL FOR A DISTANCE OF 10'-0" AWAY FROM THE STRUCTURE. TYP.
- CONFIRM ALL CONTROL JOINT LOCATIONS W/ ARCHITECT.
- CUT JOINT DEPTH TO BE 25% OF THE DEPTH OF THE SLAB.
- USE GROOVING TOOLS TO FORM JOINTS IN FRESH CONCRETE. SAW CUT JOINTS AS SOON AS CONCRETE IS HARD ENOUGH THAT THE EDGES ABUTTING THE CUT WILL NOT CHIP FROM THE SAW BLADE.

FRAMING NOTES

- ALL DIMENSIONS ARE TO FACE OF FRAMING U.N.O.
- SNAP CHALK LINES ON FLOOR FOR ALL PARTITIONS AND CONFIRM LAYOUT WITH ARCHITECT PRIOR TO CONSTRUCTION.
- USE ADVANCED FRAMING TECHNIQUES WHERE POSSIBLE TO ALLOW FOR ADDITIONAL INSULATION:
 - 3-STUD (CALIFORNIA) CORNERS
 - LADDER FRAMING AT T-WALL INTERSECTIONS
 - HEADERS CONSTRUCTED TO ALLOW FOR RIGID INSULATION ON THE INSIDE FACE
 - LIMIT FRAMING AT WINDOWS AND DOORS WHERE STRUCTURAL REQUIREMENTS PERMIT (I.E. SINGLE JACK STUDS)
 - SPACE FRAMING MEMBERS AT 19.2" O.C. WHERE STRUCTURAL REQUIREMENTS PERMIT UNLESS NOTED OTHERWISE.
- PROVIDE SOLID BLOCKING IN WALLS, CEILINGS AND ROOFS FOR STAIR HANDRAILS, BATH ACCESSORIES, GRAB BARS, WALL HUNG CABINETS, CEILING AND WALL MOUNTED LIGHT FIXTURES, CURTAIN RODS, WALL PANELING, AND INTERIOR TRIM WORK AS REQUIRED.
- PROVIDE BLOCKING PER CODE IN WALLS EXCEEDING 8 FEET IN HEIGHT FOR LATERAL STRENGTH AND/OR DRAFTSTOPPING.
- PROVIDE SOLID WOOD (DOUBLE STUD) FRAMING AROUND ALL HINGED DOOR OPENINGS FOR RIGIDITY.
- PROVIDE SOLID WOOD BLOCKING (2x4 @ 24" O.C., TYP.) BETWEEN CEILING JOISTS, RAFTERS OR TRUSSES FOR PARTITIONS RUNNING PARALLEL TO FRAMING.
- PROVIDE ADDITIONAL FLOOR JOISTS OR TRUSSES AS REQUIRED FOR PARTITIONS RUNNING PARALLEL TO FRAMING.
- CONTRACTOR TO COORDINATE ALL APPLICABLE FRAMING DETAILS & SIZING PROVIDED BY ENGINEERED LUMBER MANUFACTURER WITH THOSE SHOWN IN THE DRAWINGS.
- VERIFY BEARING POST/ JACK STUD REQUIREMENTS FOR ALL BEAMS/ HEADERS EXCEEDING 6 FT. SPANS OR WITH CONCENTRATED LOADS.
- USE ACP PRESSURE TREATED LUMBER AT ALL LOCATIONS IN DIRECT CONTACT WITH MASONRY OR CONCRETE.
- USE APPROPRIATE GALVANIZED SCREWS/ FASTENERS FOR ANCHORING PRESSURE TREATED FRAMING TO MASONRY OR CONCRETE.
- SEE STRUCTURAL/ FRAMING PLANS AND NOTES FOR ADDITIONAL FRAMING REQUIREMENTS.
- CONFIRM LAYOUT AND LOCATIONS OF ALL PLUMBING, MECHANICAL AND ELECTRICAL FIXTURES, PIPES, DUCTS, WIRES, RECESSED LIGHTING, ETC., AND ADJUST FRAMING AS NEEDED TO AVOID CONFLICTS. ADJUSTMENTS MAY REQUIRE ADDITIONAL FRAMING MEMBERS BEYOND THOSE SHOWN IN THE DRAWINGS.**

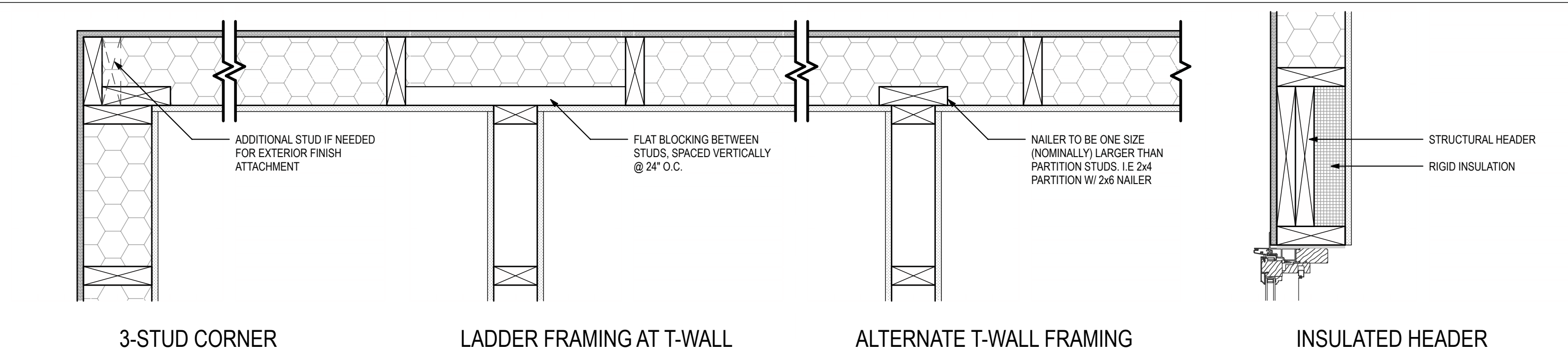

3-STUD CORNER

LADDER FRAMING AT T-WALL

ALTERNATE T-WALL FRAMING

INSULATED HEADER

SAMSEL ARCHITECTS
PA.
60 Biltmore Avenue
Asheville, NC 28801
P: 828.253.1124
F: 828.254.7316
www.samselarchitects.com

REGISTERED ARCHITECT
11501
SOUTH CAROLINA
ASHEVILLE, N.C.

REGISTERED ARCHITECT
51039
SOUTH CAROLINA
ASHEVILLE, N.C.

PROJECT:
Loftin-Skigen Renovation
14 Stuyvesant Rd
Biltmore Forest, NC 28803

SHEET TITLE:
RADON & GENERAL NOTES

DATE:	DESCRIPTION:
02.23.15	BOARD OF ADJUSTMENT
03.13.15	OWNER REVIEW
04.03.15	OWNER REVIEW
04.16.15	OWNER REVIEW
04.24.15	OWNER REVIEW
05.01.15	PERMIT SET

PROJECT #:
14.41
DRAWN BY: **DKT** CHECKED BY: **JS**
SHEET #:
A-001
COPYRIGHT 2014
SAMSEL ARCHITECTS, P.A.

GENERAL FRAMING NOTES:

1. ALL EXTERIOR WOOD FRAMED WALLS ARE 2x6's @ 16" O.C. AND INTERIOR WOOD FRAMED WALLS ARE 2x4's @ 16" O.C. , U.N.O.
2. ALL EXTERIOR DIMENSIONS ARE GIVEN TO FACE OF WALL SHEATHING OR MASONRY. ALL DIMENSIONS ARE GIVEN TO FACE OF STUDS.
3. WINDOW AND DOOR DIMENSIONS ARE GIVEN TO CENTERLINE OF UNIT; ROUGH OPENINGS AND MASONRY OPENINGS ARE PER MANUFACTURER.

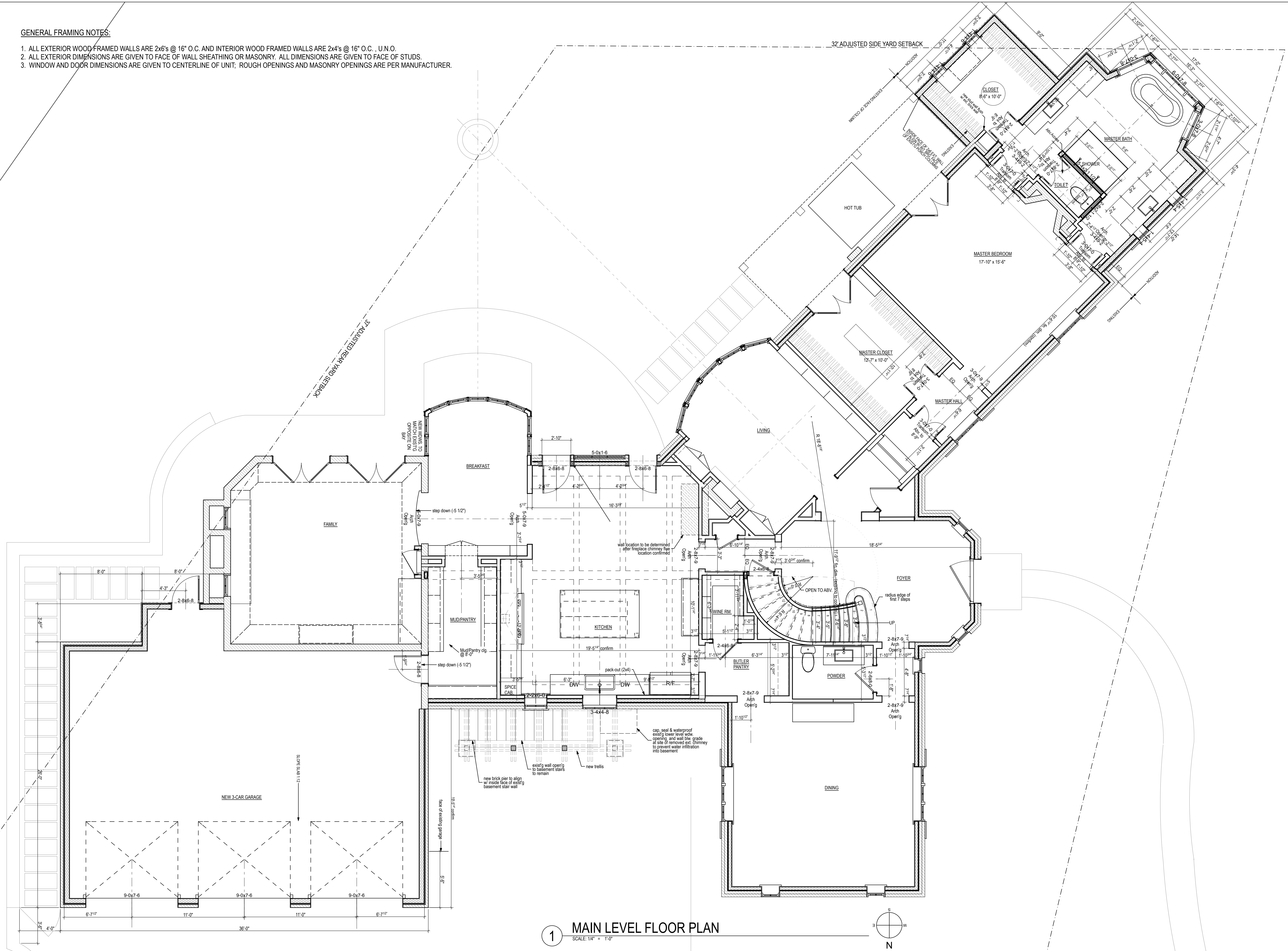

1 MAIN LEVEL FLOOR PLAN
SCALE: 1/4" = 1'-0"

SAMSEL ARCHITECTS
P.A.
60 Biltmore Avenue
Asheville, NC 28801
P: 828.253.1124
F: 828.254.7316
www.samselarchitects.com

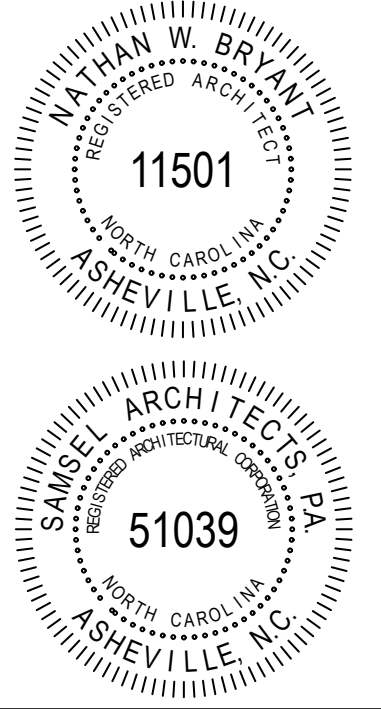

PROJECT:
**Loftin-Skigen
Renovation**

14 Stuyvesant Rd
Biltmore Forest, NC
28803

SHEET TITLE:
**MAIN LEVEL
FLOOR PLAN**

DATE:	DESCRIPTION:
02.23.15	BOARD OF ADJUSTMENT
03.13.15	OWNER REVIEW
04.03.15	OWNER REVIEW
04.16.15	OWNER REVIEW
04.24.15	OWNER REVIEW
05.01.15	PERMIT SET

PROJECT #:
14.41
DRAWN BY: **DKT** CHECKED BY: **JS**
SHEET #:

A-103
COPYRIGHT 2014
SAMSEL ARCHITECTS, P.A.

GENERAL FRAMING NOTES:

1. ALL EXTERIOR WOOD FRAMED WALLS ARE 2x6's @ 16" O.C. AND INTERIOR WOOD FRAMED WALLS ARE 2x4's @ 16" O.C. , U.N.O.
2. ALL EXTERIOR DIMENSIONS ARE GIVEN TO FACE OF WALL SHEATHING OR MASONRY. ALL DIMENSIONS ARE GIVEN TO FACE OF STUDS.
3. WINDOW AND DOOR DIMENSIONS ARE GIVEN TO CENTERLINE OF UNIT; ROUGH OPENINGS AND MASONRY OPENINGS ARE PER MANUFACTURER.

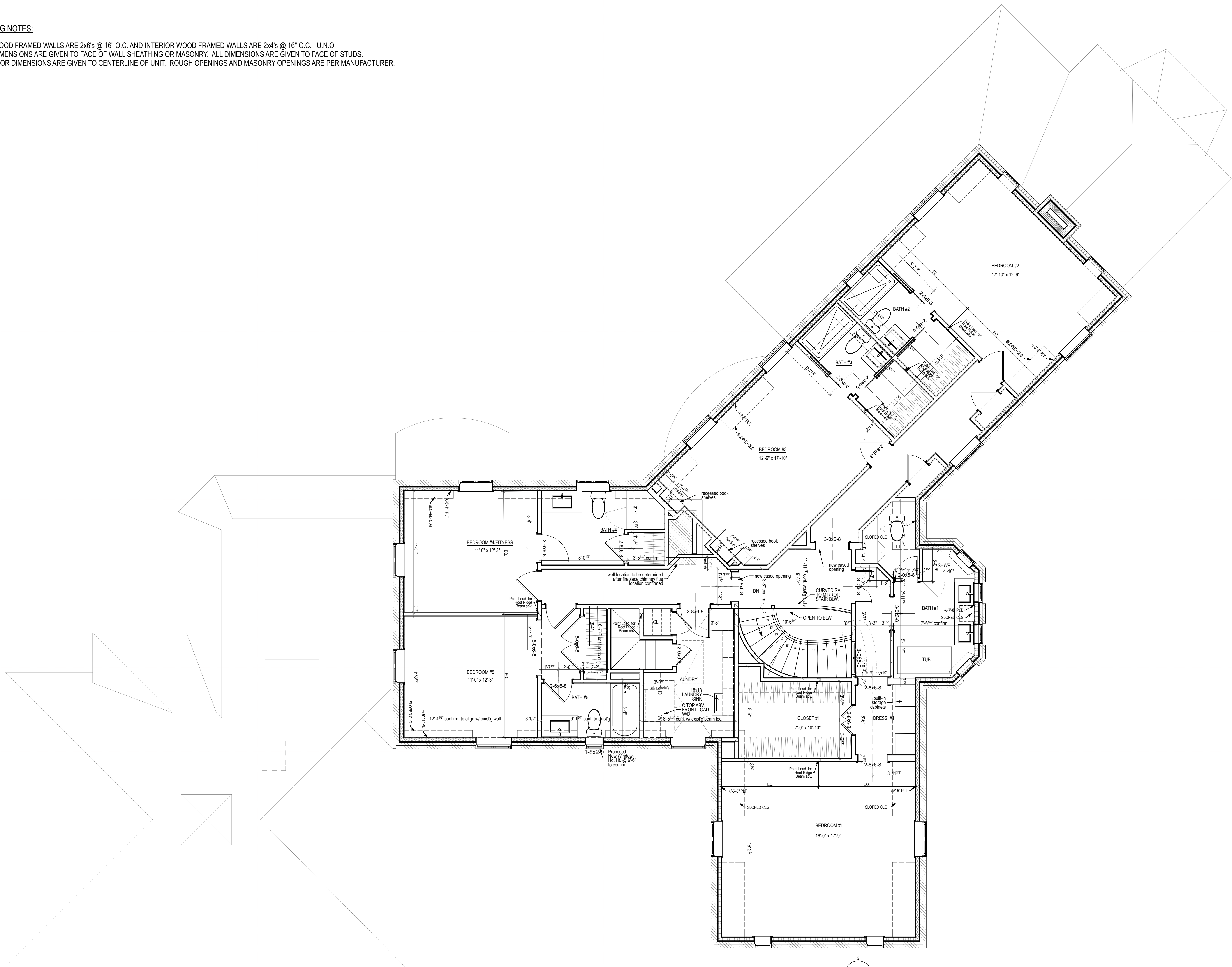

1 UPPER LEVEL FLOOR PLAN
SCALE: 1/4" = 1'-0"

SAMSEL ARCHITECTS
P.A.
60 Biltmore Avenue
Asheville, NC 28801
P: 828.253.1124
F: 828.254.7316
www.samselarchitects.com

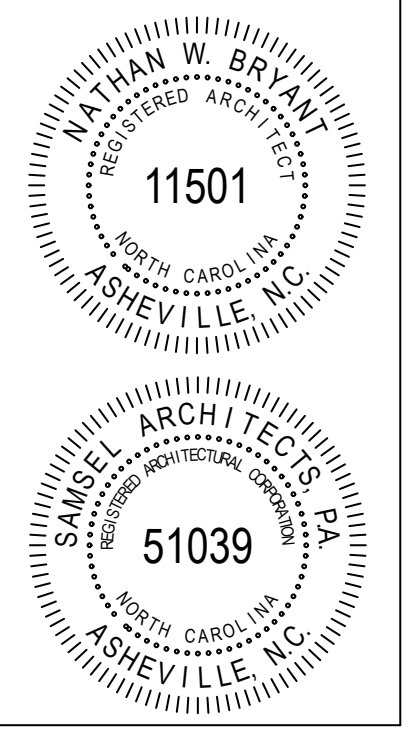

PROJECT:
Loftin-Skigen Renovation

14 Stuyvesant Rd
Biltmore Forest, NC
28803

SHEET TITLE:
UPPER LEVEL FLOOR PLAN

DATE:	DESCRIPTION:
02.23.15	BOARD OF ADJUSTMENT
03.13.15	OWNER REVIEW
04.03.15	OWNER REVIEW
04.16.15	OWNER REVIEW
04.24.15	OWNER REVIEW
05.01.15	PERMIT SET

PROJECT #:
14.41
DRAWN BY: **DKT** CHECKED BY: **JS**
SHEET #:

A-104
COPYRIGHT 2014
SAMSEL ARCHITECTS, P.A.

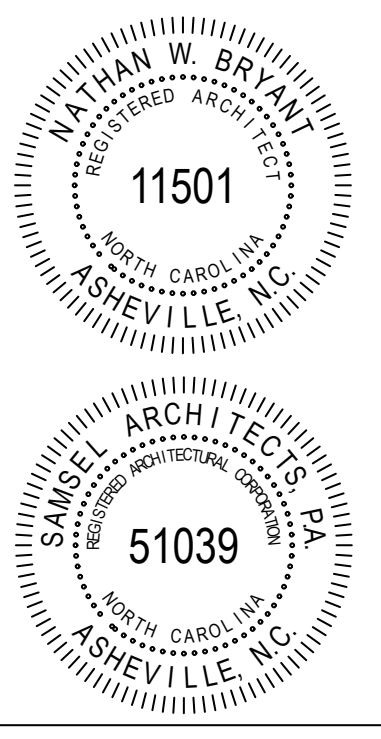

01 REAR ELEVATION
SCALE: 1/4" = 1'-0"

PROJECT:
Loftin-Skigen Renovation

14 Stuyvesant Rd
Biltmore Forest, NC
28803

SHEET TITLE:
EXTERIOR ELEVATIONS

DATE:	DESCRIPTION:
02.23.15	BOARD OF ADJUSTMENT
03.13.15	OWNER REVIEW
04.03.15	OWNER REVIEW
04.16.15	OWNER REVIEW
04.24.15	OWNER REVIEW
05.01.15	PERMIT SET

PROJECT #:
14.41
DRAWN BY: **DKT** CHECKED BY: **JS**
SHEET #:

A-201
COPYRIGHT 2014
SAMSEL ARCHITECTS, P.A.

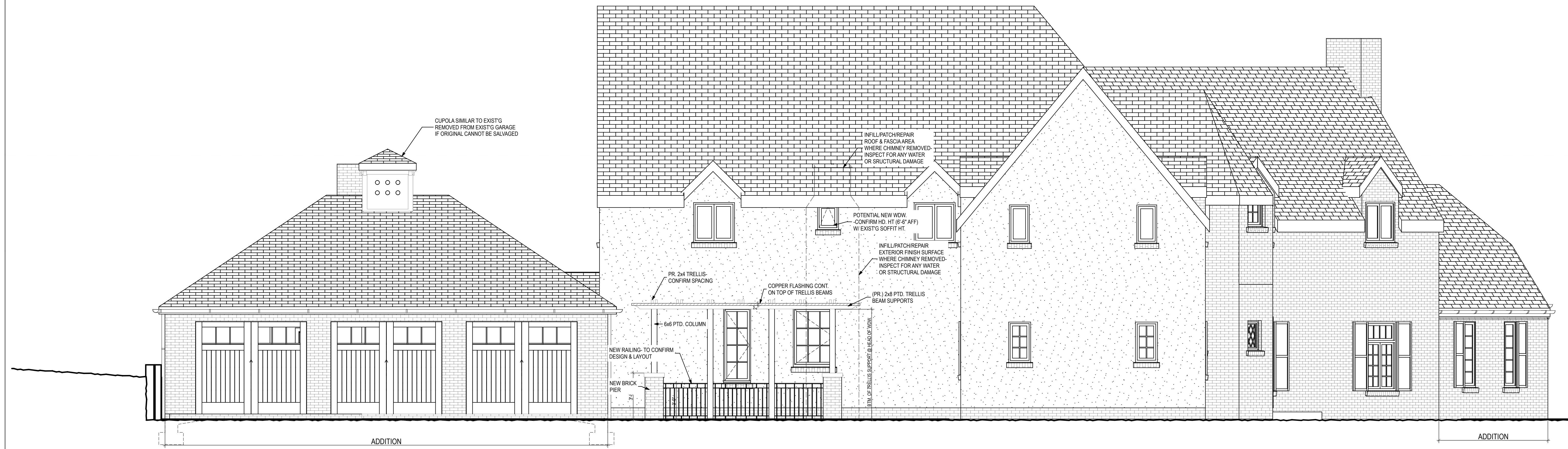

02 GARAGE SIDE ELEVATION
SCALE: 1/4" = 1'-0"



03 FRONT ELEVATION
SCALE: 1/4" = 1'-0"



04 MASTER BATH SIDE ELEVATION
SCALE: 1/4" = 1'-0"

SAMSEL ARCHITECTS
P.A.
60 Biltmore Avenue
Asheville, NC 28801
P: 828.253.1124
F: 828.254.7316
www.samselarchitects.com

NATHAN W. BRYAN
REGISTERED ARCHITECT
11501
NORTH CAROLINA
ASHEVILLE, N.C.

SAMSEL ARCHITECTS, P.A.
REGISTERED PROFESSIONAL ARCHITECTS
51039
NORTH CAROLINA
ASHEVILLE, N.C.

PROJECT:

Loftin-Skigen
Renovation

14 Stuyvesant Rd
Biltmore Forest, NC
28803

SHEET TITLE:

EXTERIOR
ELEVATIONS

DATE:	DESCRIPTION:
02.23.15	BOARD OF ADJUSTMENT
03.13.15	OWNER REVIEW
04.03.15	OWNER REVIEW
04.16.15	OWNER REVIEW
04.24.15	OWNER REVIEW
05.01.15	PERMIT SET

PROJECT #:

14.41

DRAWN BY: DKT
CHECKED BY: JS

SHEET #:

A-202

COPYRIGHT 2014
SAMSEL ARCHITECTS, P.A.



01 Master Bath Side Exterior Elevation
SCALE: 1/4" = 1'-0"



02 Master Bath Rear Exterior Elevation
SCALE: 1/4" = 1'-0"

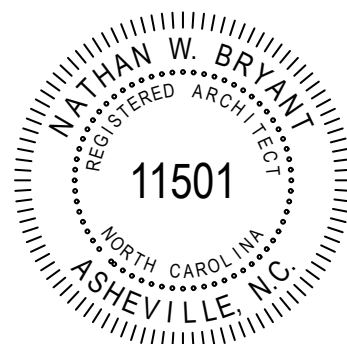

PROJECT:

Loftin-Skigen
Renovation

14 Stuyvesant Rd
Biltmore Forest, NC
28803

SHEET TITLE:

EXTERIOR
ELEVATIONS

DATE:	DESCRIPTION:
02.23.15	BOARD OF ADJUSTMENT
03.13.15	OWNER REVIEW
04.03.15	OWNER REVIEW
04.16.15	OWNER REVIEW
04.24.15	OWNER REVIEW
05.01.15	PERMIT SET

PROJECT #:

14.41

DRAWN BY: DKT
CHECKED BY: JS

SHEET #:

A-203

COPYRIGHT 2014
SAMSEL ARCHITECTS, P.A.

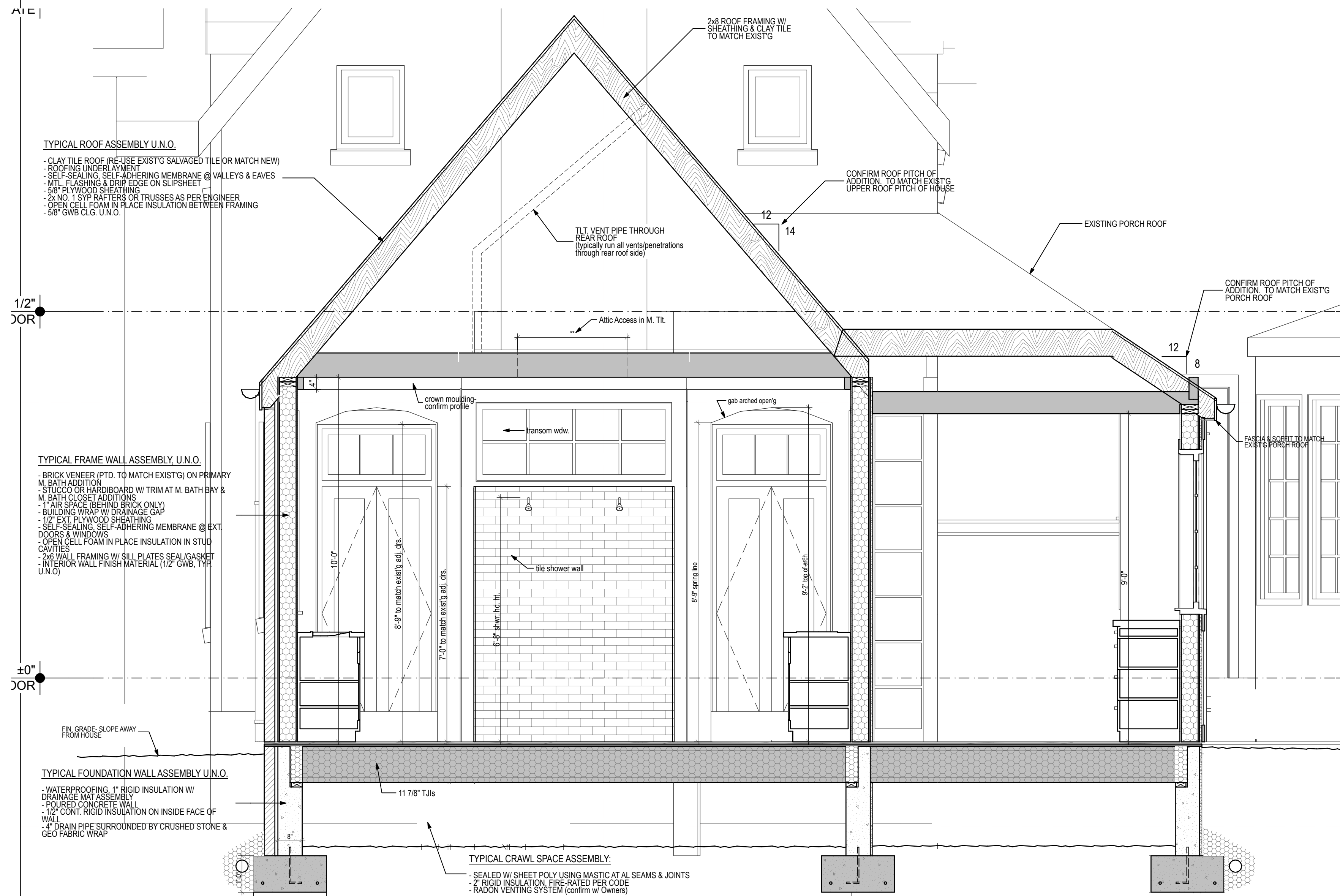

01 MASTER BATH
SCALE: 1/2" = 1'-0"

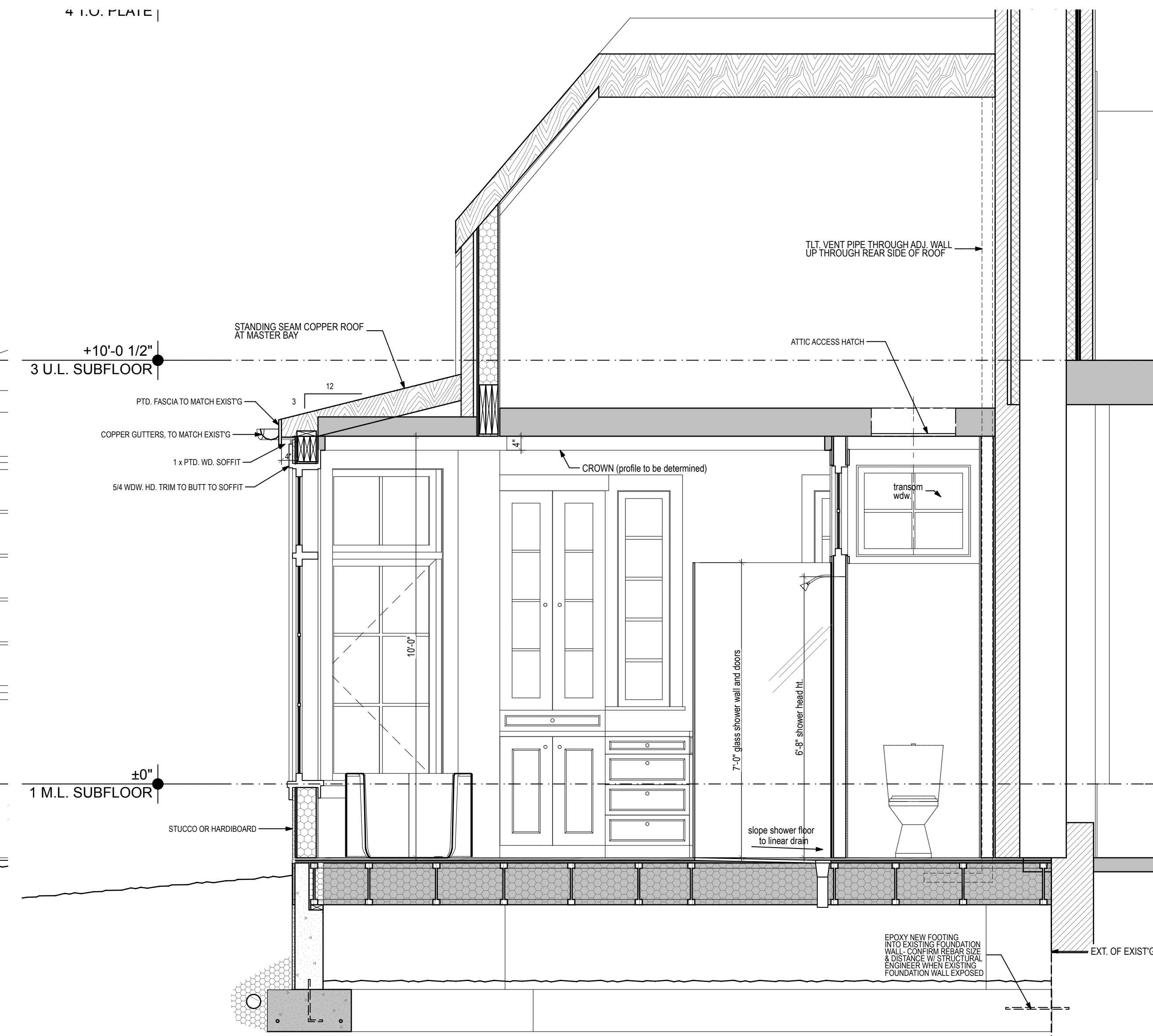

02 MASTER BATH
SCALE: 1/2" = 1'-0"

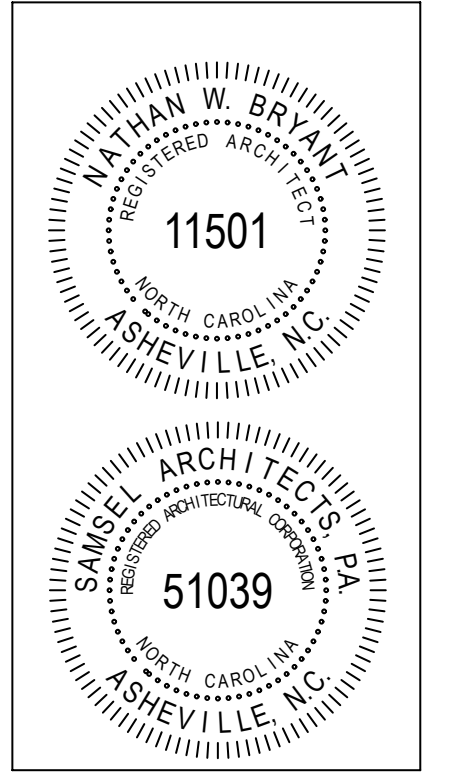

PROJECT:
**Loftin-Skigen
Renovation**

14 Stuyvesant Rd
Biltmore Forest, NC
28803

SHEET TITLE:

BUILDING SECTIONS

DATE:	DESCRIPTION:
02.23.15	BOARD OF ADJUSTMENT
03.13.15	OWNER REVIEW
04.03.15	OWNER REVIEW
04.16.15	OWNER REVIEW
04.24.15	OWNER REVIEW
05.01.15	PERMIT SET

PROJECT #:
14.41
DRAWN BY: **DKT** CHECKED BY: **JS**
SHEET #:
A-301

COPYRIGHT 2014
SAMSEL ARCHITECTS, P.A.

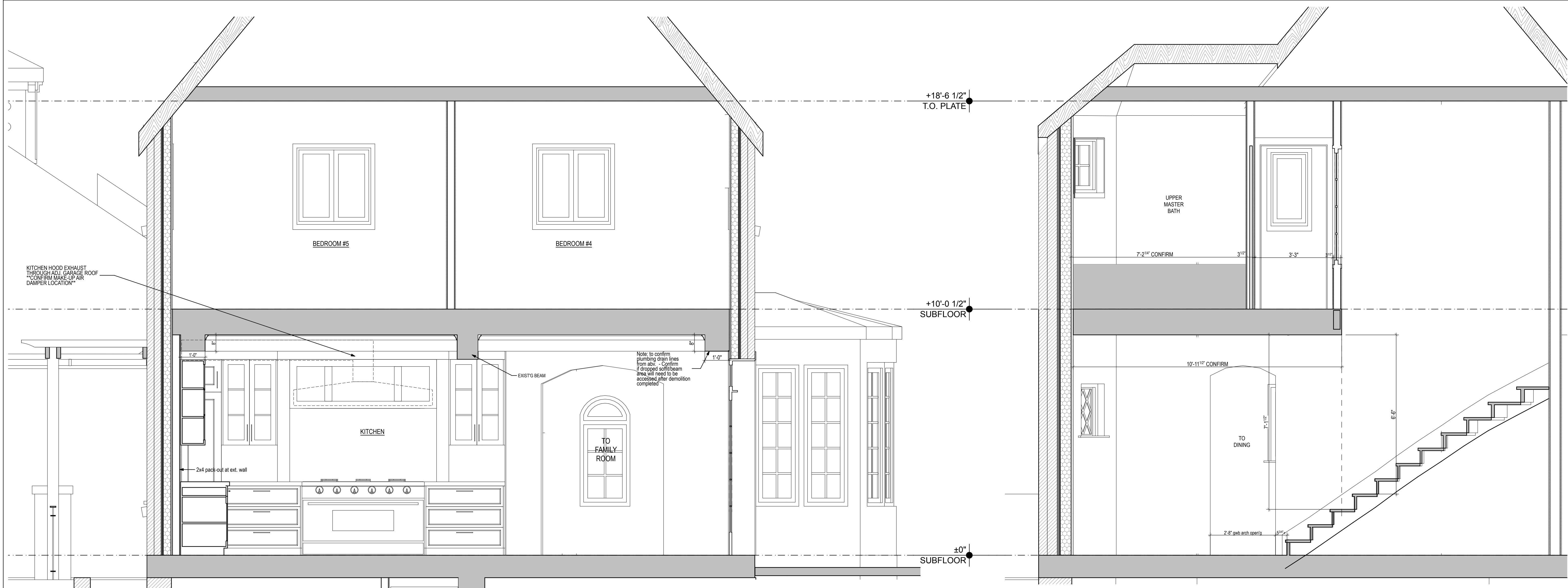
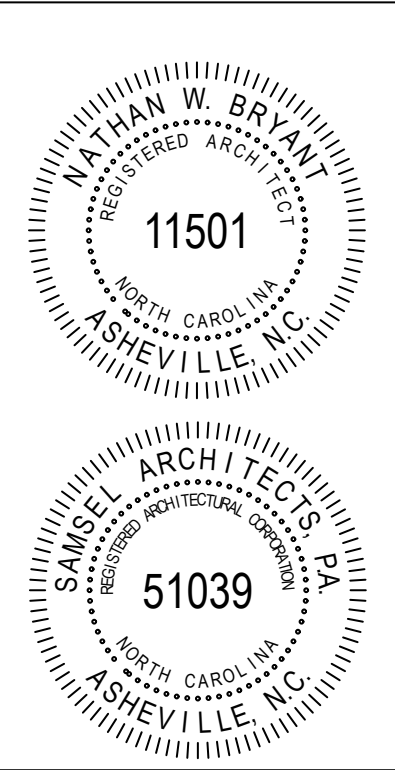

01 KITCHEN HOOD
SCALE: 1/2" = 1'-0"

02 STAIRS
SCALE: 1/2" = 1'-0"

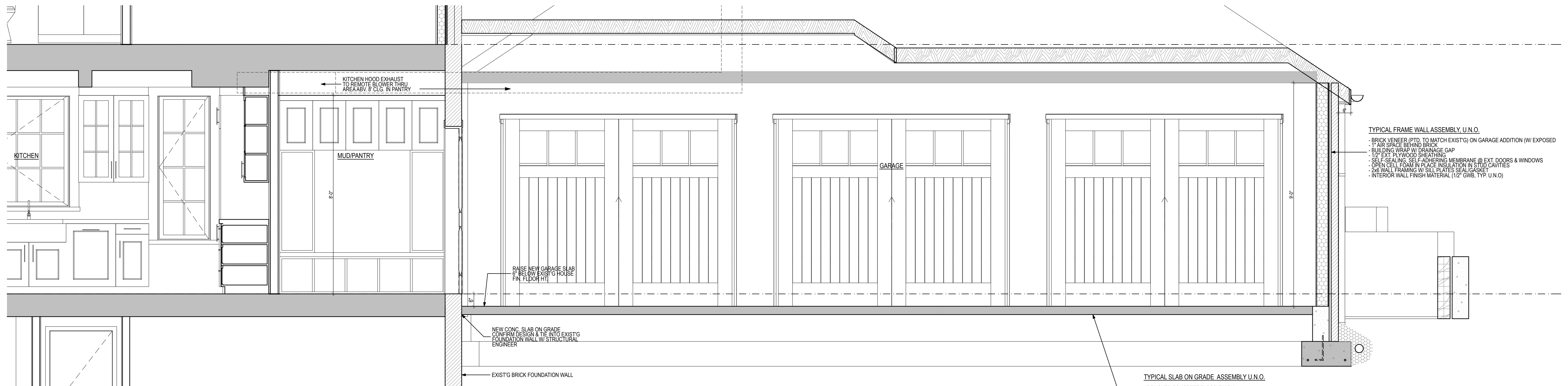

03 KITCHEN/PANTRY/GARAGE
SCALE: 1/2" = 1'-0"

PROJECT:

**Loftin-Skigen
Renovation**

14 Stuyvesant Rd
Biltmore Forest, NC
28803

SHEET TITLE:

BUILDING SECTIONS

DATE:	DESCRIPTION:
02.23.15	BOARD OF ADJUSTMENT
03.13.15	OWNER REVIEW
04.03.15	OWNER REVIEW
04.16.15	OWNER REVIEW
04.24.15	OWNER REVIEW
05.01.15	PERMIT SET

PROJECT #:

14.41

DRAWN BY: **DKT** CHECKED BY: **JS**

SHEET #:

A-302

COPYRIGHT 2014
SAMSEL ARCHITECTS, P.A.



1 KITCHEN
SCALE: 1/2" = 1'-0"



2 KITCHEN
SCALE: 1/2" = 1'-0"

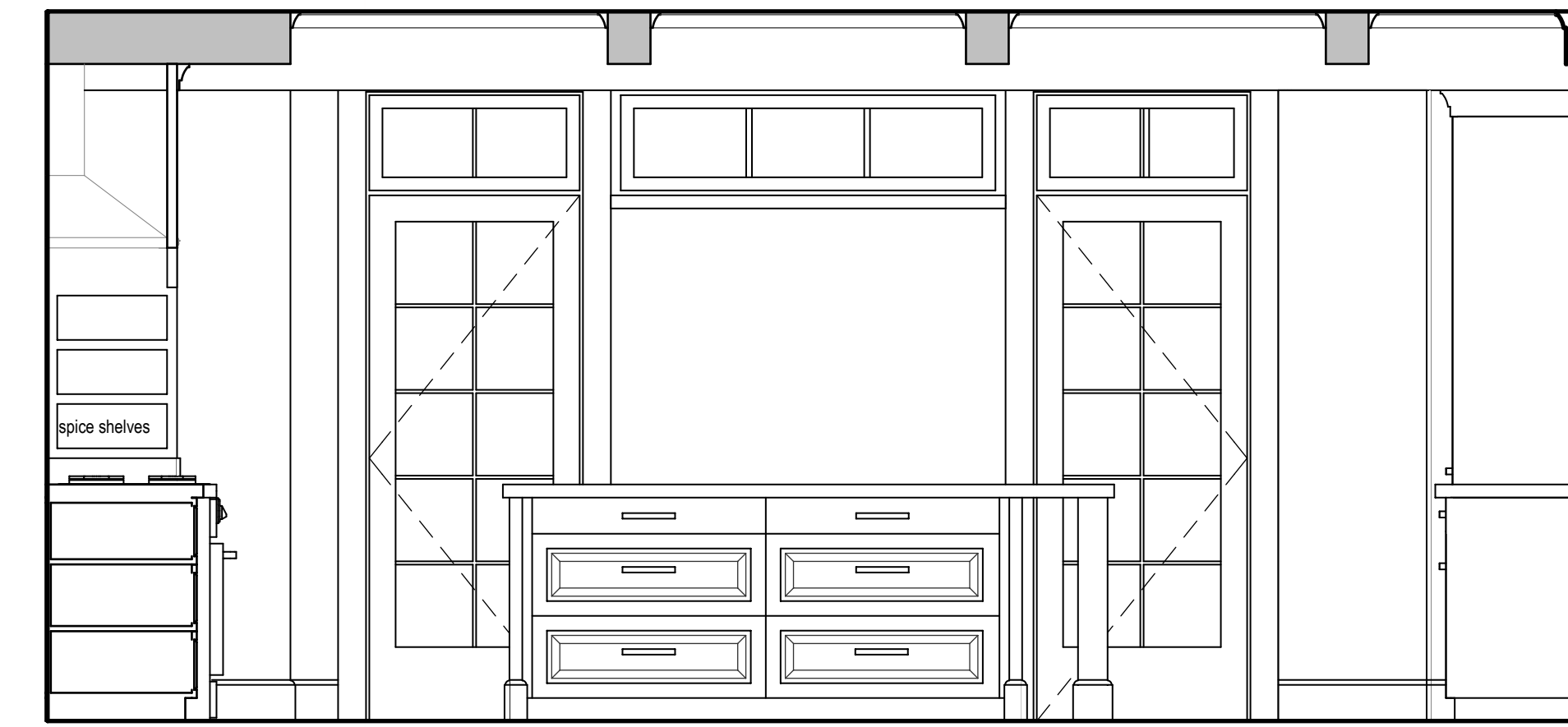

3 KITCHEN
SCALE: 1/2" = 1'-0"

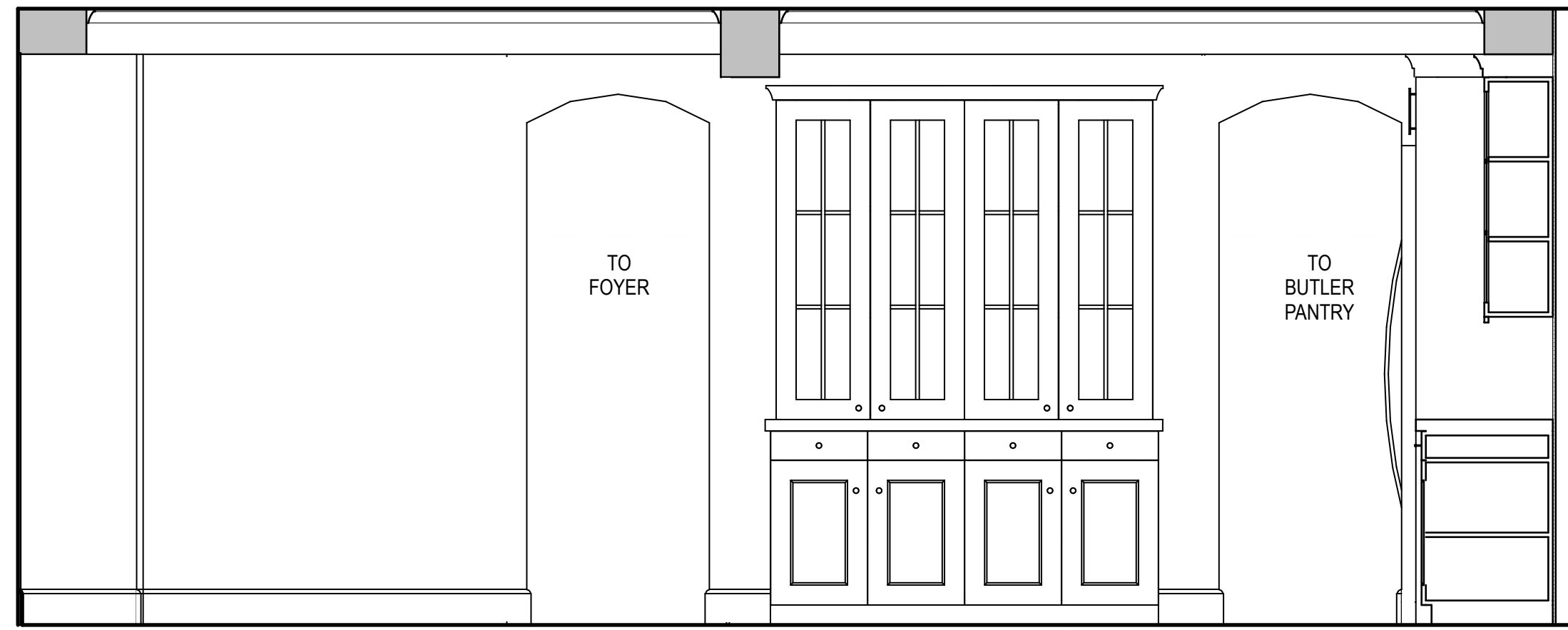

4 KITCHEN
SCALE: 1/2" = 1'-0"



5 KITCHEN
SCALE: 1/2" = 1'-0"

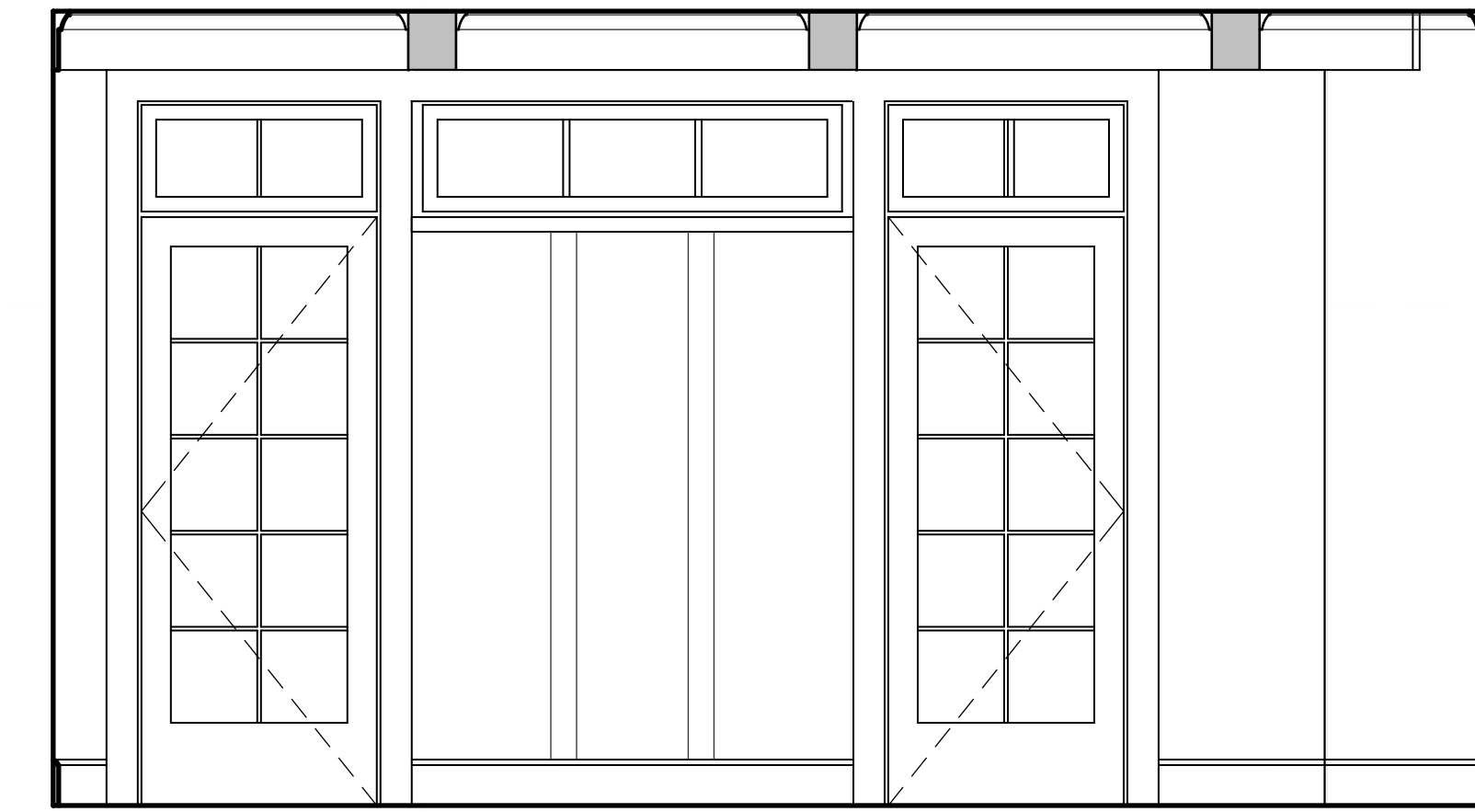

6 KITCHEN
SCALE: 1/2" = 1'-0"

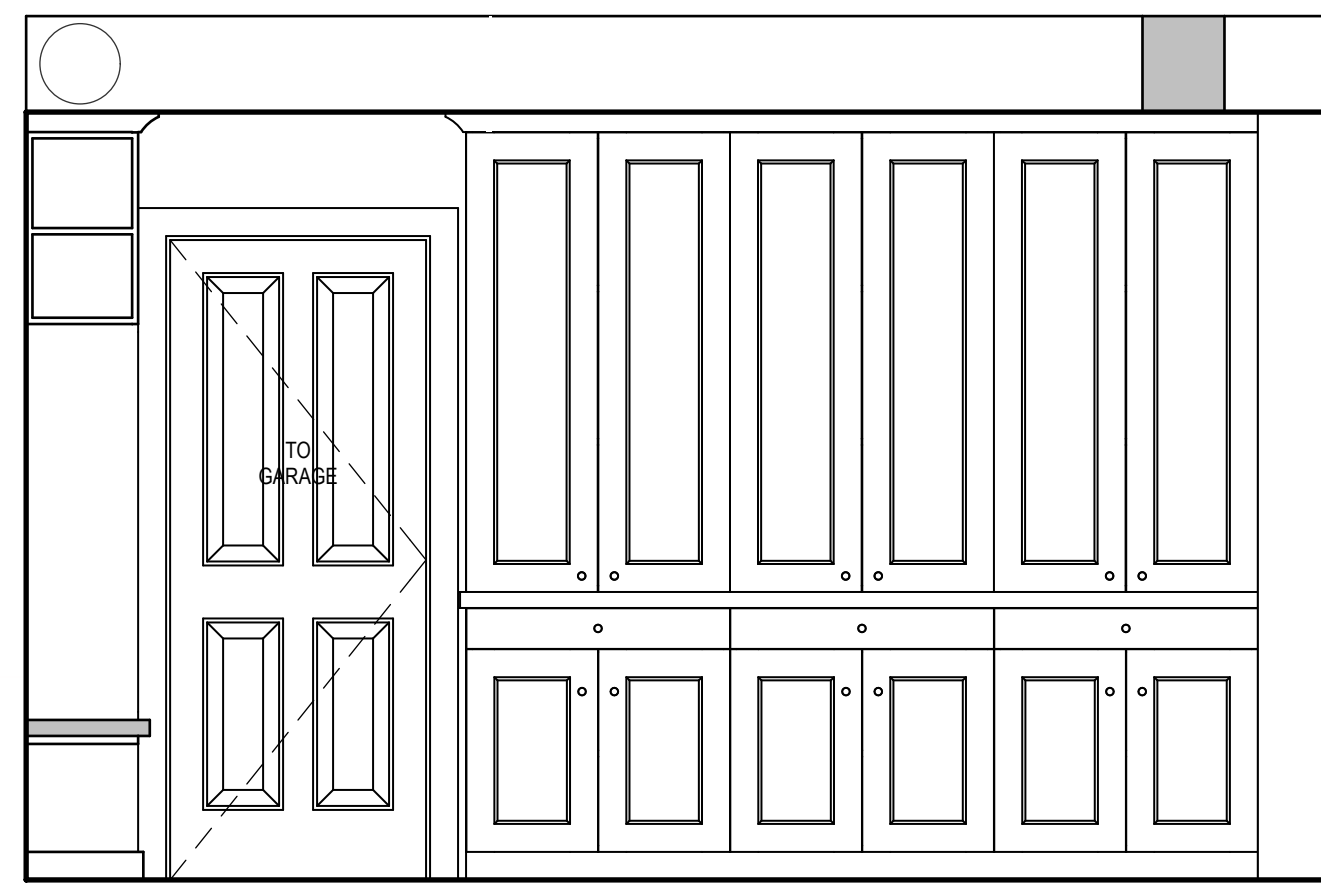

7 PANTRY
SCALE: 1/2" = 1'-0"



8 PANTRY
SCALE: 1/2" = 1'-0"

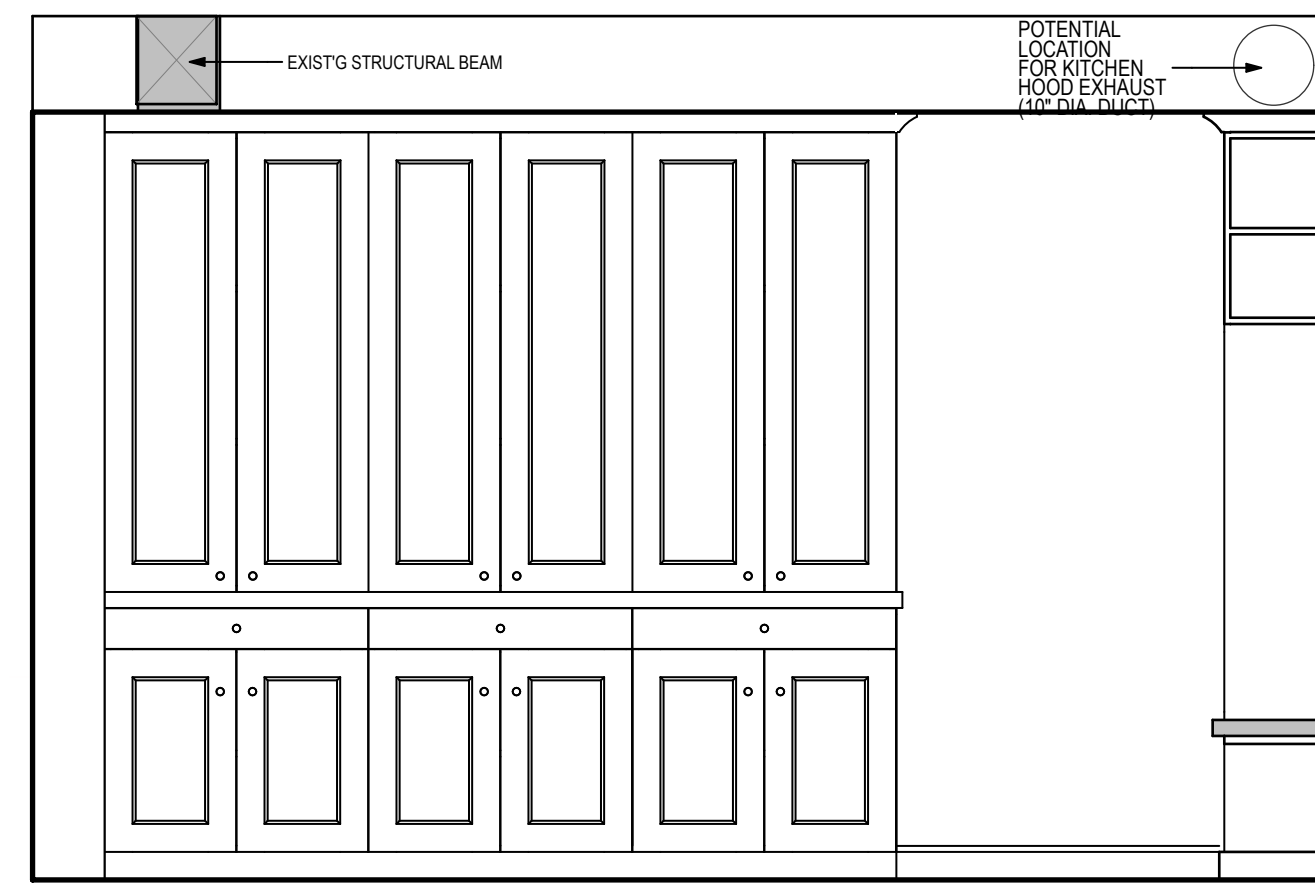

9 PANTRY
SCALE: 1/2" = 1'-0"

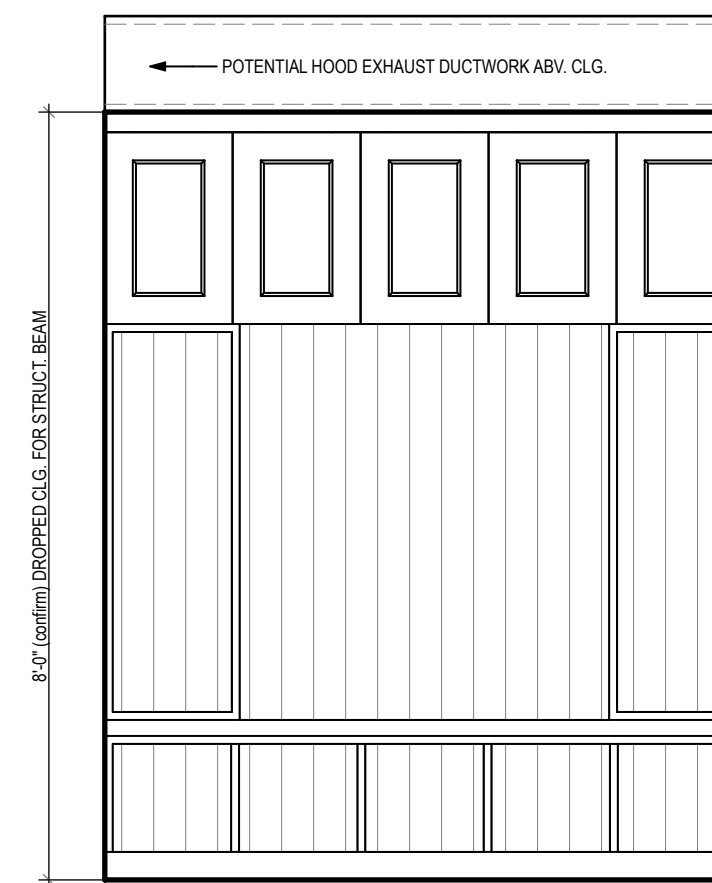

10 PANTRY
SCALE: 1/2" = 1'-0"

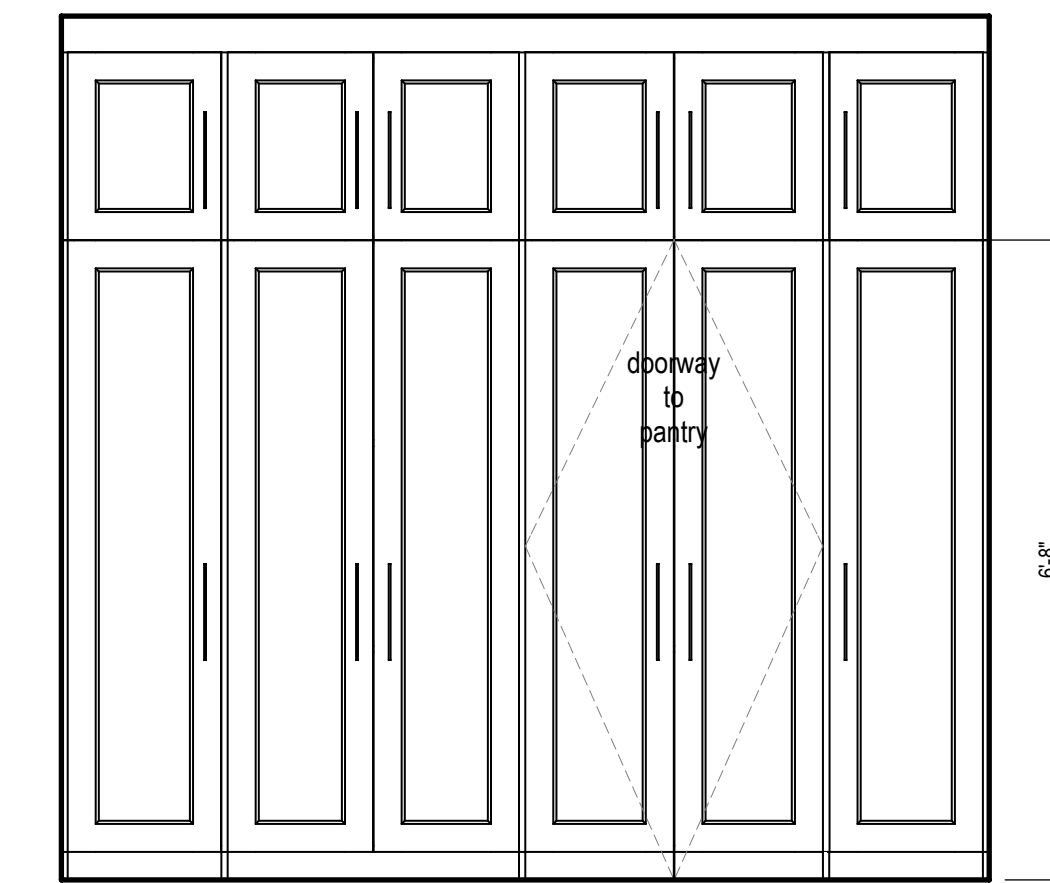

11 BREAKFAST
SCALE: 1/2" = 1'-0"

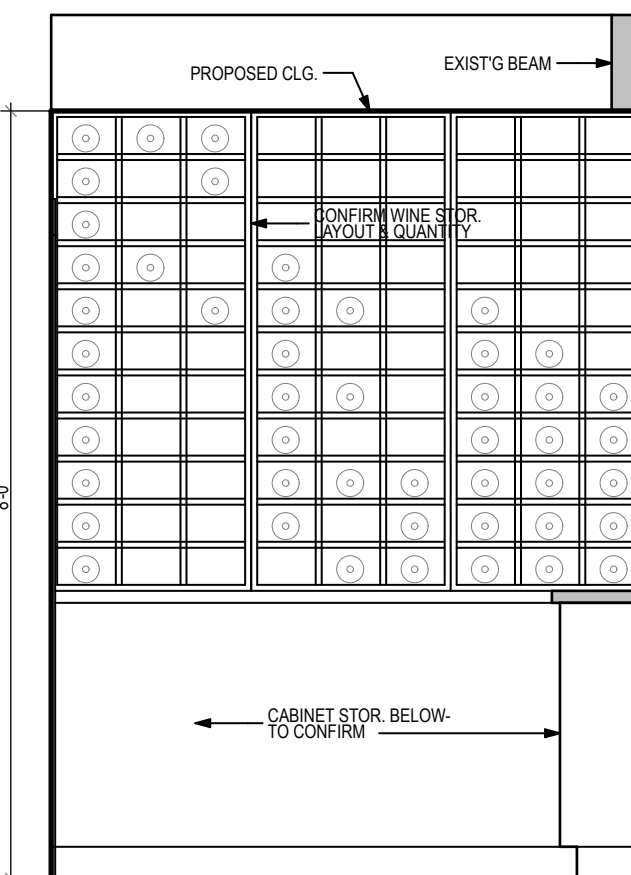

12 WINE ROOM
SCALE: 1/2" = 1'-0"

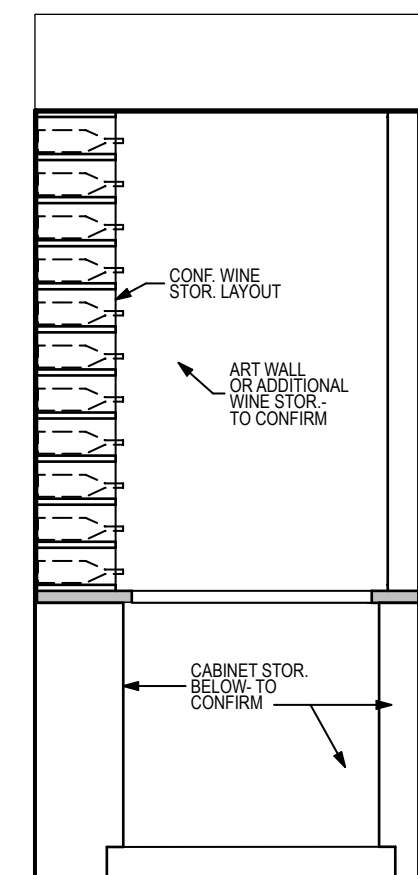

13 WINE ROOM
SCALE: 1/2" = 1'-0"

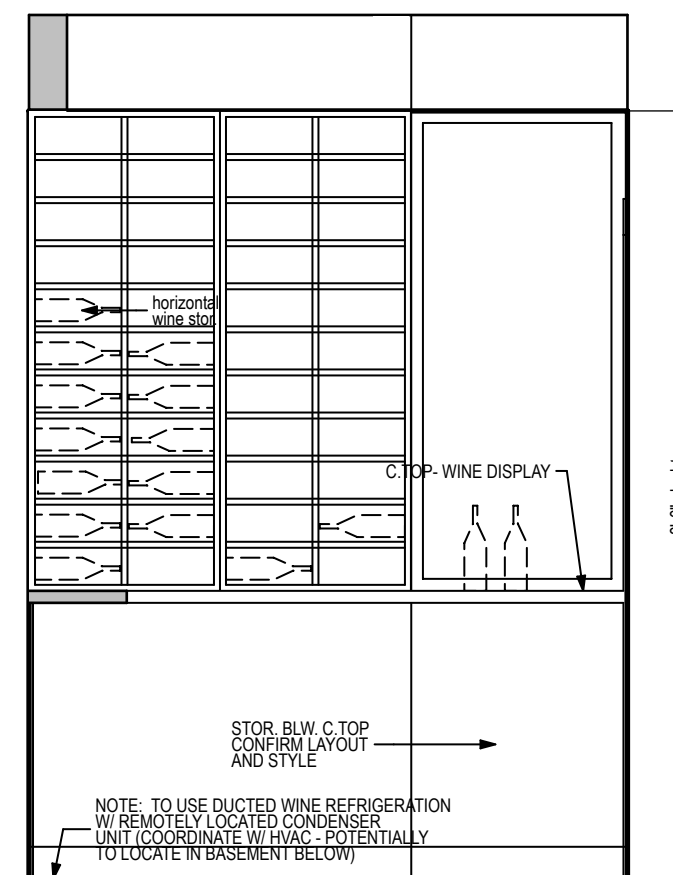

14 WINE ROOM
SCALE: 1/2" = 1'-0"

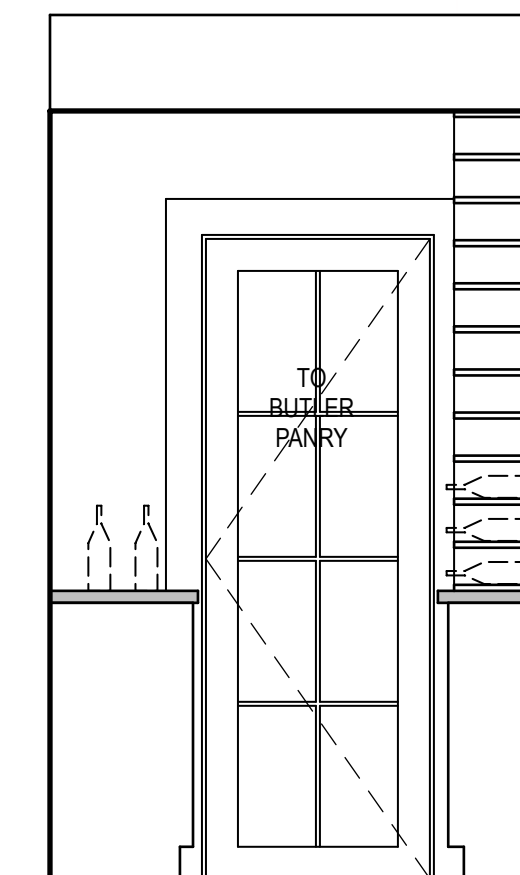

15 WINE ROOM
SCALE: 1/2" = 1'-0"

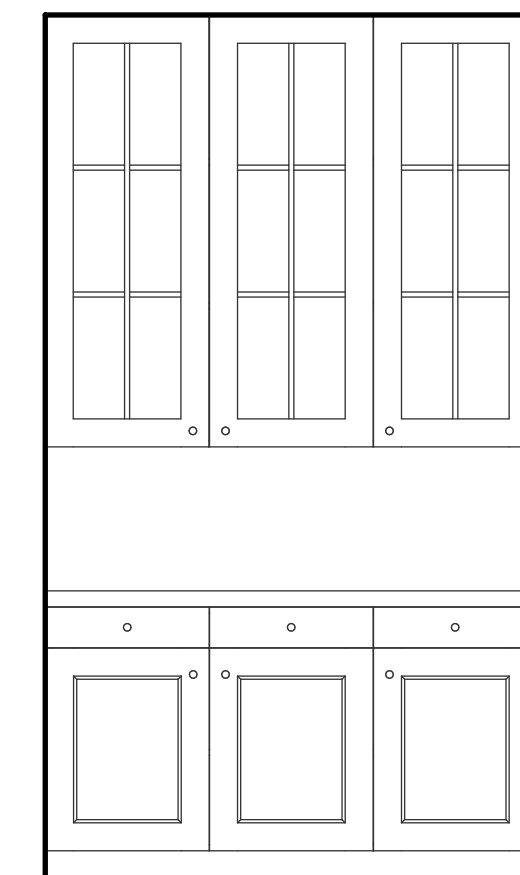

16 BUTLER PANTRY
SCALE: 1/2" = 1'-0"

PRELIMINARY INTERIOR ELEVATIONS- FOR INTENT ONLY
NOT FOR CONSTRUCTION

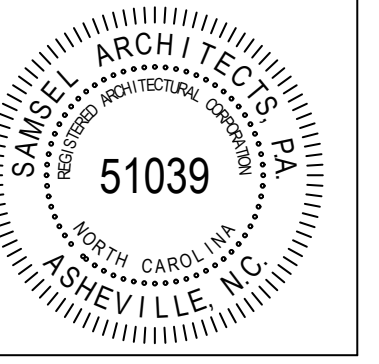
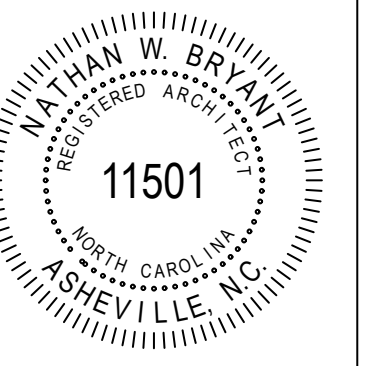

PROJECT:

Loftin-Skigen
Renovation

14 Stuyvesant Rd
Biltmore Forest, NC
28803

SHEET TITLE:

INTERIOR
ELEVATIONS

DATE:	DESCRIPTION:
02.23.15	BOARD OF ADJUSTMENT
03.13.15	OWNER REVIEW
04.03.15	OWNER REVIEW
04.16.15	OWNER REVIEW
04.24.15	OWNER REVIEW
05.01.15	PERMIT SET

PROJECT #:

14.41

DRAWN BY: DKT

CHECKED BY: JS

SHEET #:

A-501

COPYRIGHT 2014
SAMSEL ARCHITECTS, P.A.

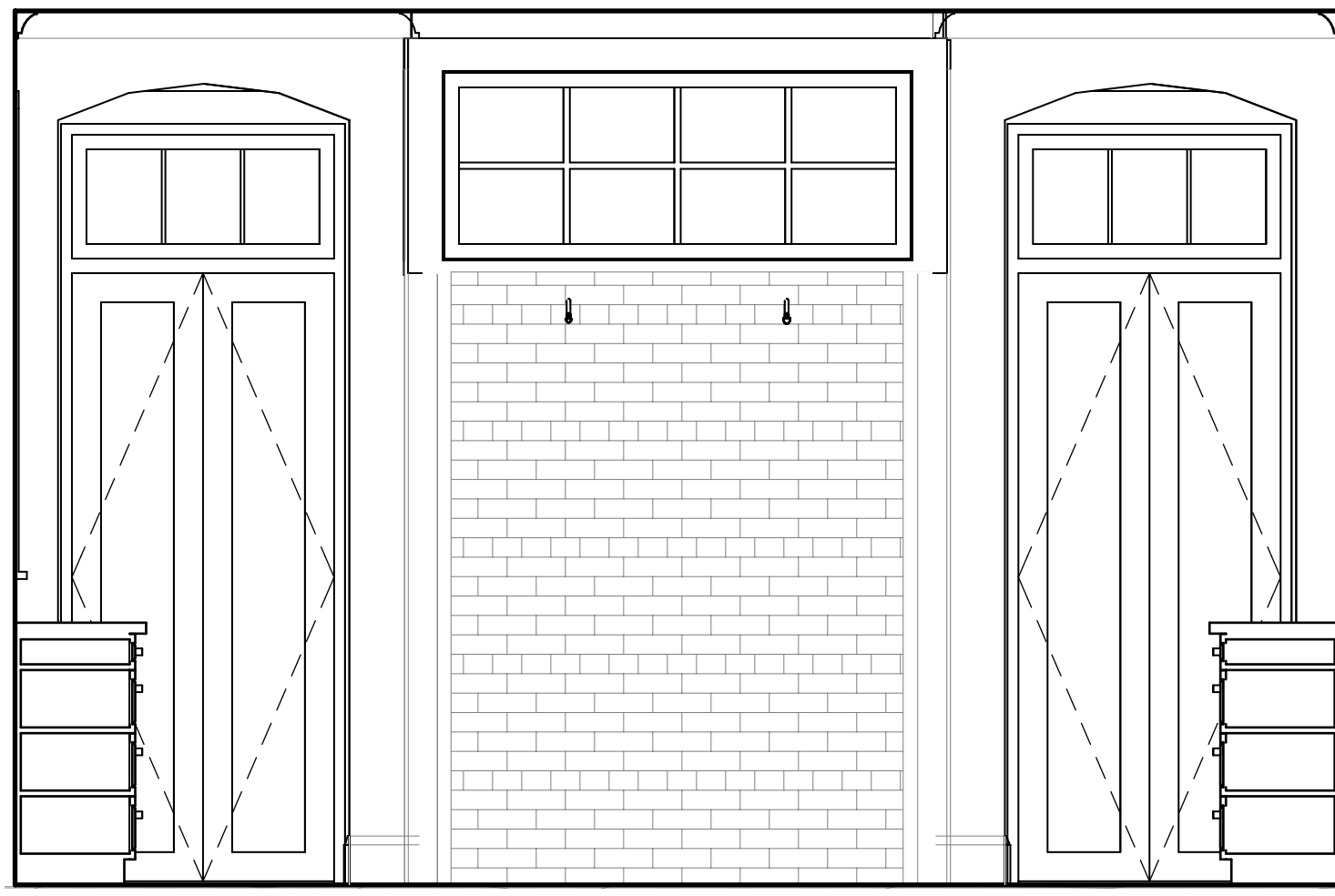

1 MASTER BATH
SCALE: 1/2" = 1'-0"

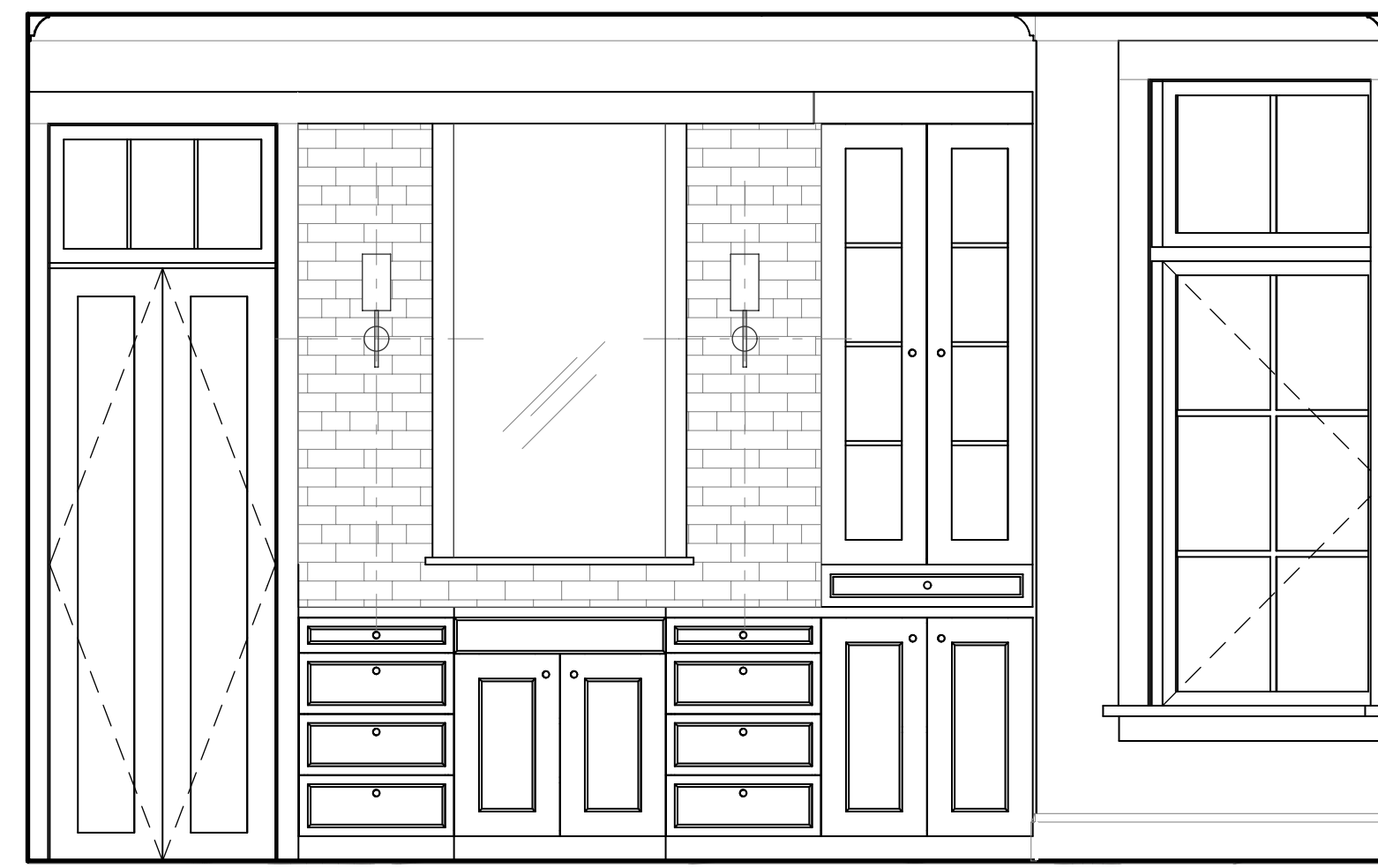

2 MASTER BATH
SCALE: 1/2" = 1'-0"

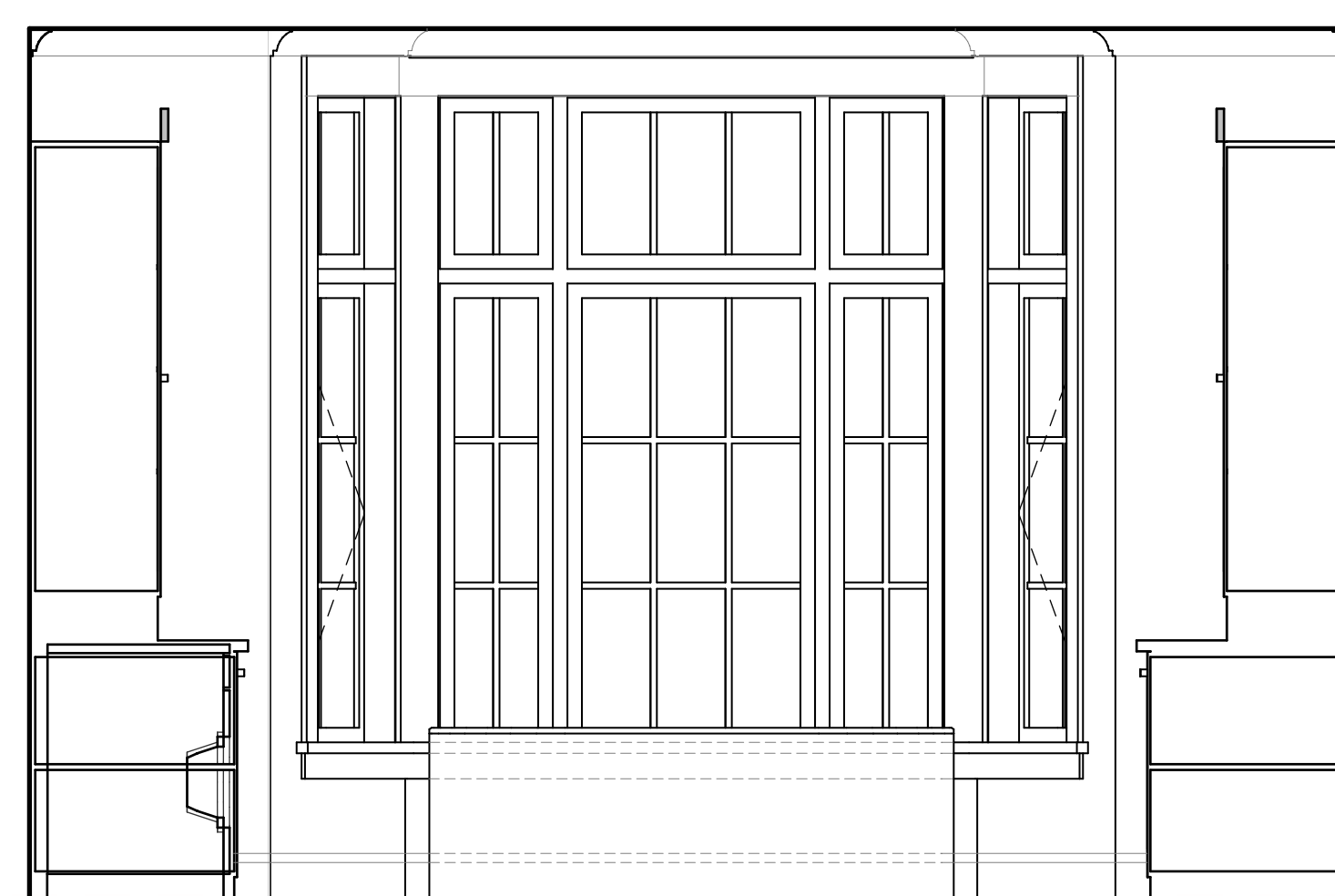

3 MASTER BATH
SCALE: 1/2" = 1'-0"

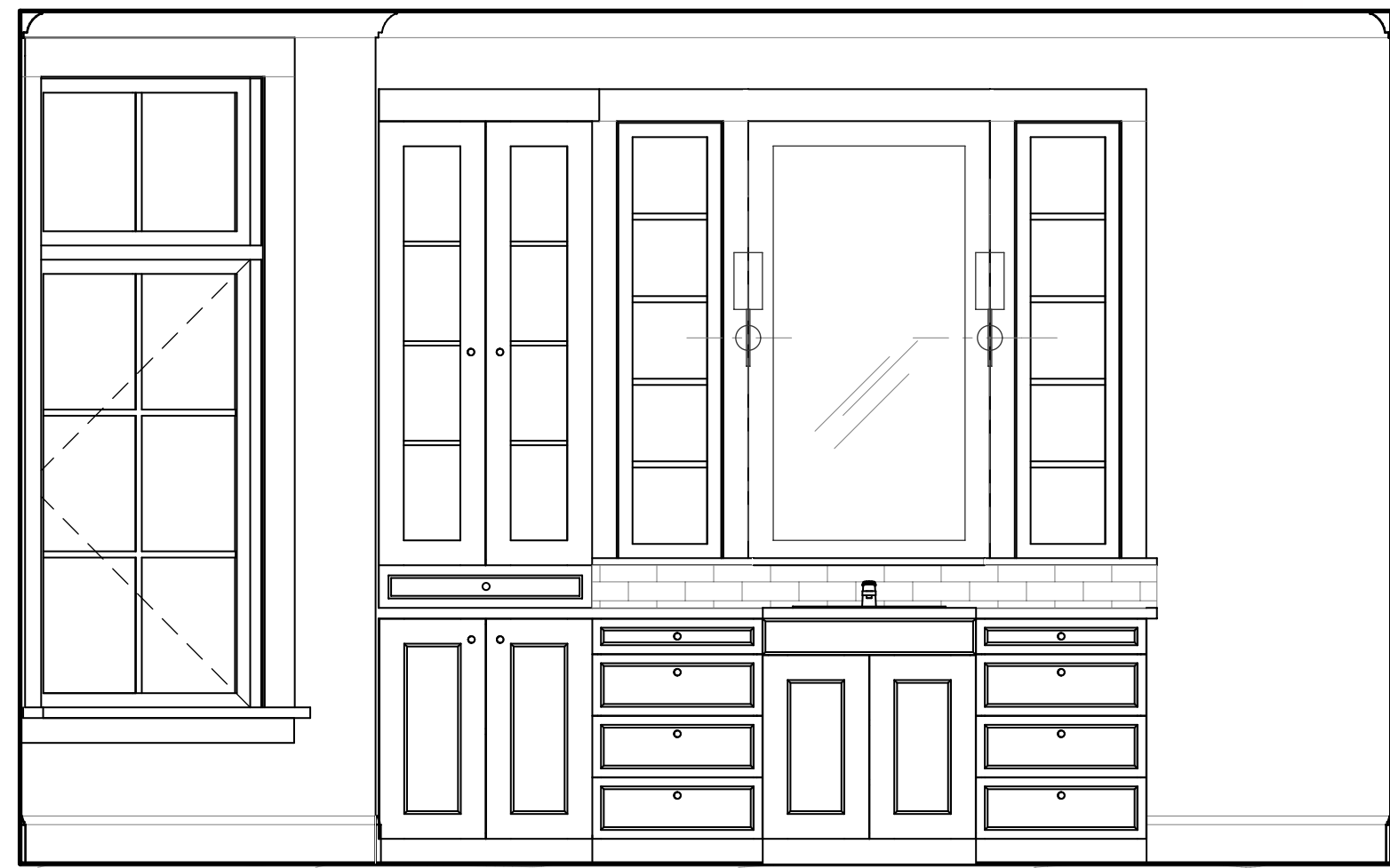

4 MASTER BATH
SCALE: 1/2" = 1'-0"

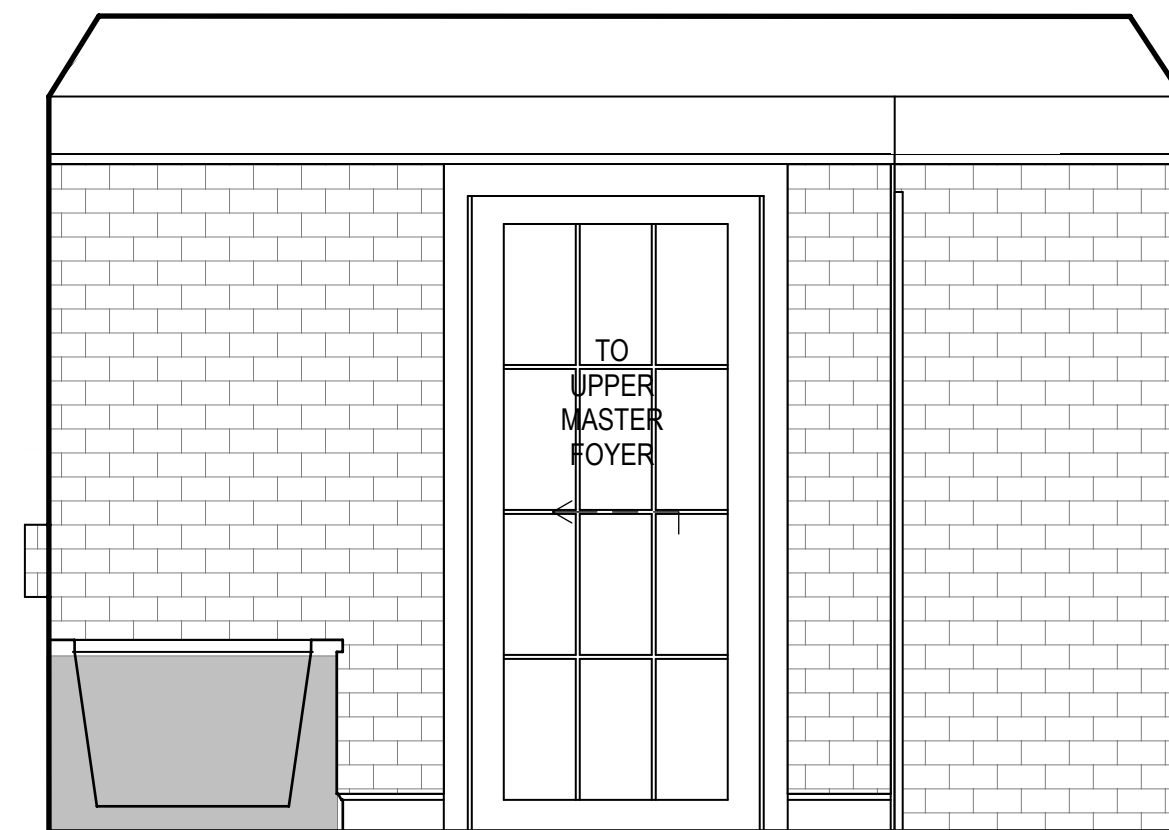

5 UPPER MASTER BATH
SCALE: 1/2" = 1'-0"

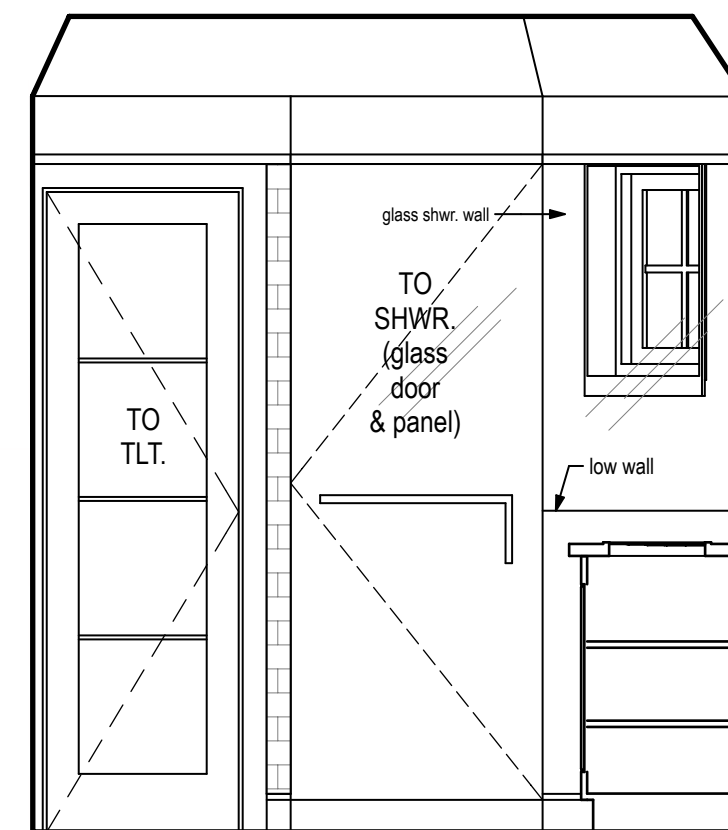

6 UPPER MASTER BATH
SCALE: 1/2" = 1'-0"



7 UPPER MASTER BATH
SCALE: 1/2" = 1'-0"

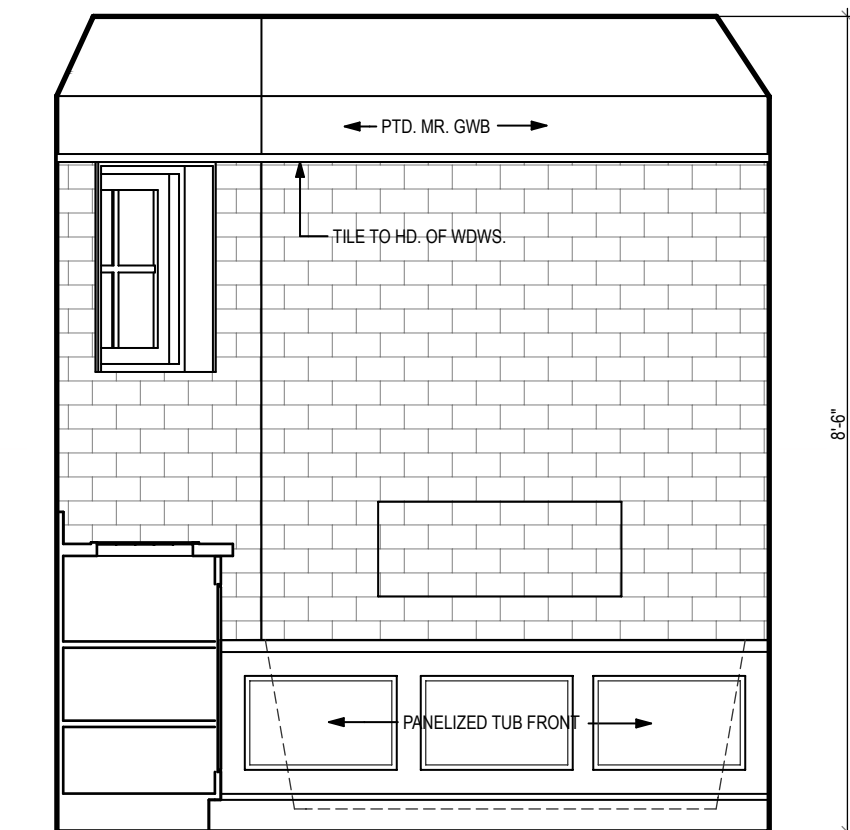

8 UPPER MASTER BATH
SCALE: 1/2" = 1'-0"

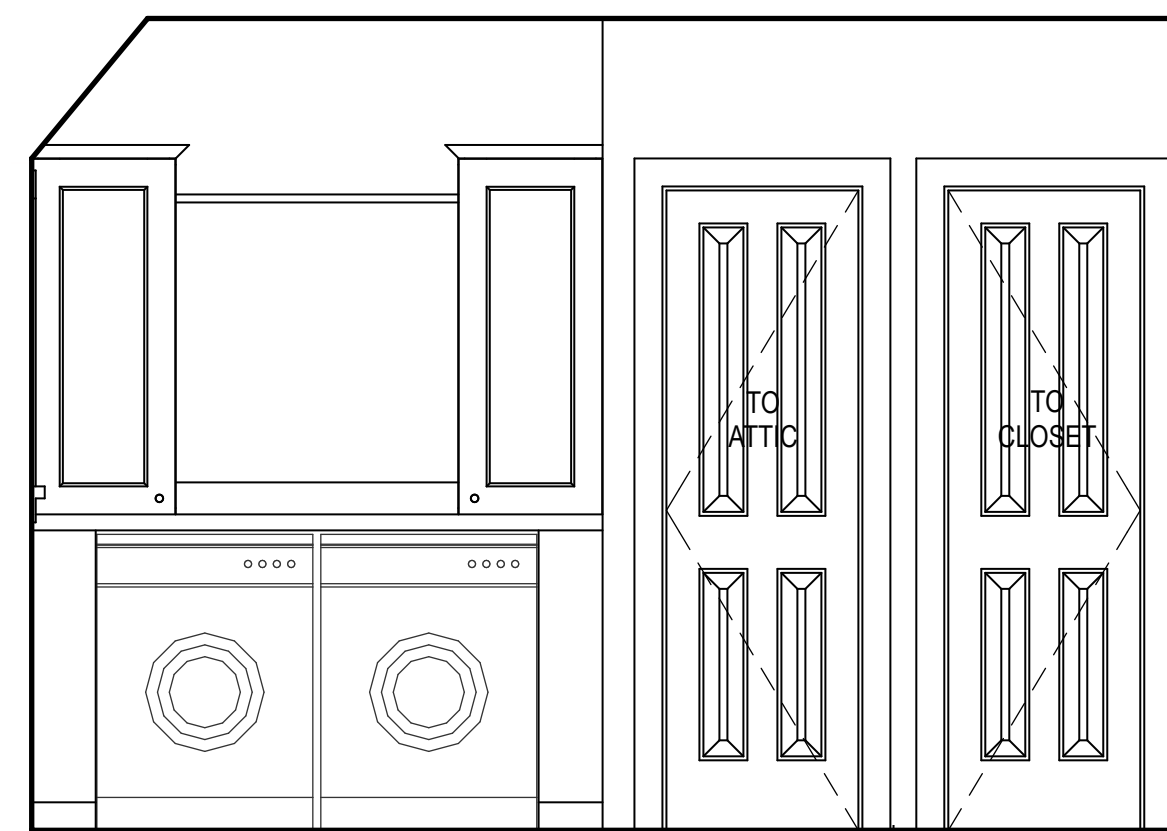

9 LAUNDRY
SCALE: 1/2" = 1'-0"



10 LAUNDRY
SCALE: 1/2" = 1'-0"

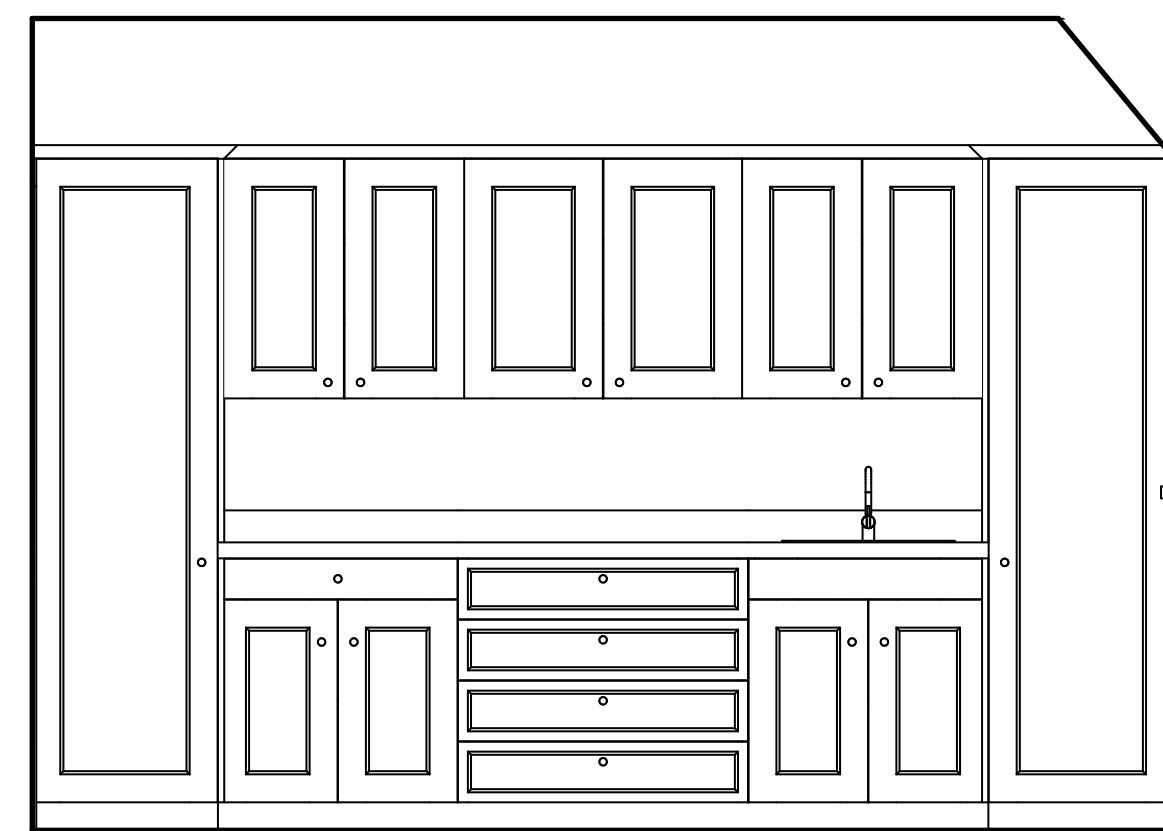

11 LAUNDRY
SCALE: 1/2" = 1'-0"

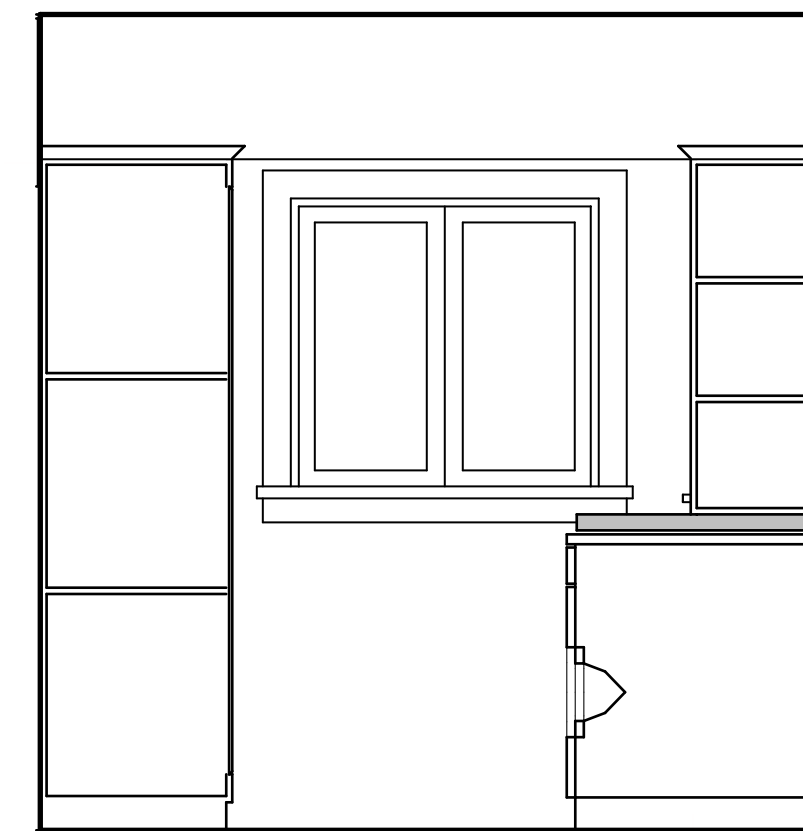

12 LAUNDRY
SCALE: 1/2" = 1'-0"

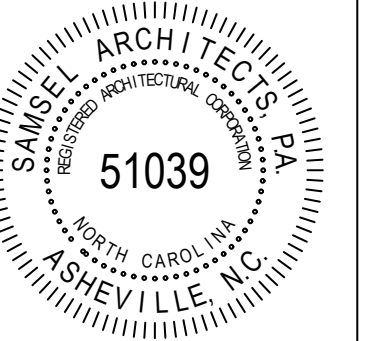
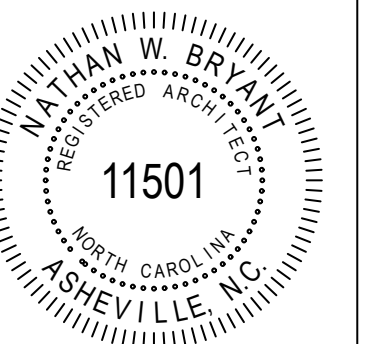

PROJECT:

Loftin-Skigen
Renovation

14 Stuyvesant Rd
Biltmore Forest, NC
28803

SHEET TITLE:

INTERIOR
ELEVATIONS

DATE:	DESCRIPTION:
02.23.15	BOARD OF ADJUSTMENT
03.13.15	OWNER REVIEW
04.03.15	OWNER REVIEW
04.16.15	OWNER REVIEW
04.24.15	OWNER REVIEW
05.01.15	PERMIT SET

PROJECT #:

14.41

DRAWN BY: DKT

CHECKED BY: JS

SHEET #:

A-502

COPYRIGHT 2014
SAMSEL ARCHITECTS, P.A.

DEMOLITION NOTES

GENERAL

- CONFIRM BEARING CAPACITY OF EXISTING STRUCTURE FOR ALL NEW CONSTRUCTION WITH STRUCTURAL ENGINEER.
- PROVIDE PROTECTIVE MEASURES AS REQUIRED TO PROVIDE FREE AND SAFE PASSAGE FROM OCCUPIED PORTIONS OF BUILDING.
- PERFORM SELECTIVE DEMOLITION WORK IN A SYSTEMATIC MANNER, USING SUCH METHODS AS REQUIRED TO COMPLETE WORK INDICATED IN THE DRAWINGS IN ACCORDANCE WITH DEMOLITION SCHEDULE AND GOVERNING REGULATIONS.
- DEMOLISH CONCRETE AND MASONRY IN SMALL SECTIONS. MAKE CLEAN CUTS AT LOCATIONS WHERE EXISTING ELEMENTS ARE TO REMAIN USING POWER-DRIVEN MASONRY SAW OR HAND TOOLS.
- PROVIDE INTERIOR AND EXTERIOR SHORING, BRACING OR SUPPORTS TO PREVENT MOVEMENT, SETTLEMENT OR COLLAPSE OF EXISTING STRUCTURES. CEASE OPERATIONS AND NOTIFY THE OWNER, OCCUPANTS AND THE ARCHITECT IMMEDIATELY IF SAFETY OF STRUCTURE APPEARS TO BE COMPROMISED. TAKE PRECAUTIONS TO SUPPORT STRUCTURE UNTIL DETERMINATION IS MADE FOR CONTINUING OPERATIONS.
- PROTECT EXISTING ELEMENTS THAT ARE TO REMAIN FROM DAMAGE DURING THE DEMOLITION PROCESS.
- PROTECT FLOORS WITH SUITABLE COVERING AS NEEDED.
- COVER AND PROTECT FURNITURE, EQUIPMENT AND FIXTURES THAT ARE TO REMAIN FROM SOILING OR DAMAGE DURING THE DEMOLITION PROCESS.
- PROVIDE TEMPORARY WEATHER PROTECTION DURING THE INTERVAL BETWEEN DEMOLITION AND NEW CONSTRUCTION TO ENSURE THAT NO WATER LEAKAGE OR DAMAGE OCCURS TO STRUCTURE OR INTERIOR AREAS OF EXISTING BUILDING.
- MAINTAIN EXISTING UTILITIES AS INDICATED IN THE DRAWINGS, KEEP IN SERVICE AND PROTECT AGAINST DAMAGE DURING DEMOLITION PROCESS.
- IF EXISTING MECHANICAL, ELECTRICAL OR STRUCTURAL ELEMENTS CONFLICT WITH THEIR INTENDED FUNCTION OR DESIGN AS SHOWN IN THE DRAWINGS, INVESTIGATE AND MEASURE BOTH NATURE AND EXTENT OF THE CONFLICT AND SUBMIT AN ACCURATE, DETAILED WRITTEN REPORT TO THE ARCHITECT, OWNER OR THEIR REPRESENTATIVE. PENDING RECEIPT OF DIRECTIVE FROM THE OWNER OR THEIR REPRESENTATIVE, REARRANGE SELECTIVE DEMOLITION SCHEDULE AS NECESSARY TO CONTINUE OVERALL JOB PROGRESS WITHOUT DELAY.
- REPAIR DEMOLITION PERFORMED IN EXCESS OF WHAT IS REQUIRED FOR PLANNED CONSTRUCTION. RETURN STRUCTURES AND SURFACES THAT ARE TO REMAIN TO THEIR PRE-EXISTING CONDITION. REPAIR ADJACENT CONSTRUCTION OR SURFACES DAMAGED DURING THE DEMOLITION PROCESS.
- CHECK EXISTING CONSTRUCTION FOR PLUMB, LEVEL AND SQUARE IN ALL AREAS TO BE RENOVATED. NOTE AND DESCRIBE ANY DISCREPANCIES TO THE OWNER OR THEIR REPRESENTATIVE FOR REVIEW PRIOR TO BEGINNING NEW CONSTRUCTION.

PLUMBING

- PERFORM PLUMBING REVIEW WITH PLUMBER TO CONFIRM TIE-IN TO EXISTING PLUMBING LINES AND CONDITION OF EXISTING PLUMBING AND FIXTURES AND PROVIDE RECOMMENDATIONS, PRICING AND SCHEDULING TO THE ARCHITECT, OWNER OR THEIR REPRESENTATIVE.

ELECTRICAL

- PERFORM ELECTRICAL REVIEW WITH ELECTRICIAN TO REVIEW CURRENT PANEL SIZE AND CONDITION OF EXISTING WIRING AND FIXTURES AND PROVIDE RECOMMENDATIONS, PRICING AND SCHEDULING TO THE ARCHITECT, OWNER OR THEIR REPRESENTATIVE.

MECHANICAL

- PERFORM MECHANICAL REVIEW WITH HVAC CONTRACTOR TO CONFIRM CONDITION OF EXISTING EQUIPMENT AND LINES, CONFIRM PROPOSED LOCATIONS FOR RELOCATED OR NEW EQUIPMENT, LINES, DUCTS, SUPPLY REGISTERS, RETURN GRILLES AND THERMOSTAT LOCATIONS. PROVIDE RECOMMENDATIONS, PRICING AND SCHEDULING TO THE ARCHITECT, OWNER OR THEIR REPRESENTATIVE.

FOYER

- CONFIRM EXISTING CLG./U.L. FLR. FRAMING ABOVE.
- REMOVE ANY EXISTING CLG./U.L. FLOOR FRAMING AS NECESSARY TO ACCOMMODATE NEW OPENING. CONSULT WITH STRUCTURAL ENGINEER AS REQUIRED PRIOR TO REMOVAL OF ANY FRAMING FOR SIZING, LOAD AND STRUCTURAL ENGINEERING.
- REMOVAL OF EXISTING STAIRS TO OCCUR AFTER VERIFICATION OF CLG./U.L. FLOOR FRAMING IN FOYER. CONSULT STRUCTURAL ENGINEER AS REQUIRED FOR NEW U.L. FLOOR FRAMING/OPENING/STAIR LANDING.
- WILL NEED TO PROVIDE TEMPORARY STAIR ACCESS IF BOTH FRONT AND REAR STAIRS REMOVED AT SAME TIME.
- REMOVE EXISTING LIGHTING FIXTURES. CONFIRM WITH OWNERS IF TO SALVAGE.

LIVING ROOM

- REMOVE EXTERIOR WINDOWS ADJACENT TO FIREPLACE AS INDICATED.
- REMOVE PORTION OF EXTERIOR WALL ADJACENT TO DEMOLISHED WINDOWS TO ACCOMMODATE NEW DOOR OPENINGS INTO NEW MASTER BATH.

COAT CLOSET

- REMOVE HALL SIDE AND REAR WALLS. PROVIDE ANY TEMPORARY BRACING AS MAY BE REQUIRED. CONSULT STRUCTURAL ENGINEER AS NECESSARY.
- REMOVE ARCHED OPENINGS BETWEEN DINING AND FOYER. PROVIDE ANY TEMPORARY BRACING AS MAY BE REQUIRED. CONSULT STRUCTURAL ENGINEER AS NECESSARY.
- REMOVE ALL INTERIOR SHELVES/RODS ETC.
- REMOVE EXISTING PLASTER/WALL FINISH LEAVING STUDS EXPOSED ON FRAMING TO REMAIN.

POWDER

- REMOVE EXISTING PLUMBING FIXTURES. CONFIRM WITH OWNERS IF TO SALVAGE.
- REMOVE ALL ACCESSORIES AND LIGHTING FIXTURES. CONFIRM WITH OWNERS IF TO SALVAGE.
- REMOVE ALL WALLS AS INDICATED ON DEMOLITION PLAN.

DINING ROOM

- REMOVE EXISTING POCKET DOOR. CONFIRM WITH OWNERS IF TO SALVAGE.

FAMILY ROOM

- REMOVE EXISTING EXTERIOR WINDOWS. CONFIRM WITH OWNERS IF TO SALVAGE.
- REMOVE PORTION OF EXISTING EXTERIOR WALLS AS INDICATED ON PLAN TO ALLOW FOR NEW WINDOWS. CONFIRM NEW HEADER LOCATION AND FRAMING REQUIREMENTS AS NECESSARY.
- REMOVE EXISTING FIREPLACE AND CHIMNEY. CONSULT STRUCTURAL ENGINEER AS NECESSARY TO CONFIRM ANY LOAD OR STRUCTURAL ISSUES.
- CONFIRM PORTION OF EXTERIOR WALL TO REMAIN IN PLACE FOR EXTERIOR STAIRS TO BASEMENT.
- INTERIOR REAR STAIR REMOVAL. CONFIRM THAT TEMPORARY STAIR ACCESS TO UPPER LEVEL MAINTAINED. CONSULT STRUCTURAL ENGINEER AS REQUIRED TO CONFIRM LOAD OR FRAMING REQUIREMENTS.
- REMOVE SMALL CLOSET AT REAR STAIR INCLUDING DOOR. SALVAGE DOOR.
- REMOVE ALL LIGHTING FIXTURES. CONFIRM WITH OWNERS IF TO SALVAGE.
- REMOVE ALL PLASTER/WALL FINISH LEAVING STUDS EXPOSED ON FRAMING TO REMAIN AS NECESSARY FOR ALL NEW ELECTRICAL/PLUMBING/MECHANICAL WORK REQUIRED FOR NEW KITCHEN.
- CONFIRM POINT LOAD LOCATIONS OF EXISTING PRIMARY LOAD BEARING BEAM. BEAM TO REMAIN. CONFIRM LOAD CARRIED AND PROPERLY SUPPORTED DOWN THROUGH BASEMENT FOUNDATION. CONFIRM NO CONFLICT IN POINT LOAD SUPPORT RELATIVE TO NEW PLAN LAYOUT. ALERT ARCHITECT IF ANY CONFLICT EXISTS AND CONSULT STRUCTURAL ENGINEER IF ANY ISSUES DISCOVERED DURING DEMOLITION.

KITCHEN

- REMOVE ALL EXISTING CABINETS, APPLIANCES, LIGHTING AND PLUMBING FIXTURES. CONFIRM WITH OWNERS IF TO SALVAGE.
- REMOVE INTERIOR WALLS AS INDICATED ON DEMOLITION PLANS. NOTE ANY STRUCTURAL/DAMAGE/PME ISSUES DISCOVERED DURING DEMOLITION. ALERT ARCHITECT IF ANY ISSUES DISCOVERED.
- REMOVE EXISTING EXTERIOR WINDOWS. CONFIRM WITH OWNERS IF TO SALVAGE.
- REMOVE PORTION OF EXTERIOR WALL ADJACENT TO WINDOWS AS INDICATED ON DEMOLITION PLAN. PREP FOR NEW HEADERS AS REQUIRED FOR NEW EXTERIOR DOORS AND WINDOWS. CONSULT WITH STRUCTURAL ENGINEER AS NECESSARY.

BREAKFAST

- REMOVE EXISTING WINDOW SEAT FRAMING.
- REMOVE EXISTING EXTERIOR DOOR AND PORTION OF WALL ADJACENT TO ALLOW FOR NEW WINDOWS. PREP FOR NEW HEADER AS REQUIRED. CONSULT WITH STRUCTURAL ENGINEER AS NECESSARY.
- REMOVE EXISTING LIGHTING FIXTURES. CONFIRM WITH OWNERS IF TO SALVAGE.

REAR POWDER

- REMOVE EXISTING CABINETS, PLUMBING AND LIGHTING FIXTURES. CONFIRM WITH OWNERS IF TO SALVAGE.
- REMOVE WALLS AS INDICATED ON DEMOLITION PLAN. NOTE ANY STRUCTURAL/DAMAGE/PME ISSUES DISCOVERED DURING DEMOLITION. ALERT ARCHITECT IF ANY ISSUES DISCOVERED. CONSULT STRUCTURAL ENGINEER IF ANY STRUCTURAL ISSUES DISCOVERED DURING DEMOLITION.

MUD ROOM

- REMOVE ALL WALLS AND DOORS AS INDICATED ON DEMOLITION PLAN. PREP FOR NEW HEADERS AS REQUIRED FOR NEW DOOR TO GARAGE. CONSULT WITH STRUCTURAL ENGINEER AS NECESSARY.
- REMOVE ALL PLASTER/WALL FINISH LEAVING STUDS EXPOSED ON FRAMING.

FAMILY ROOM

- CONFIRM W/ OWNERS IF TO DEMOLISH EXISTING SKYLIGHT IN THIS ROOM. WILL NEED TO CONFIRM ROOF FRAMING/FINISH AND ANY POTENTIAL WATER PENETRATION ISSUES PRIOR TO REMOVAL.
- TO CONFIRM ANY OTHER DEMOLITION IN THIS ROOM WITH OWNERS.

GARAGE

- TO DEMOLISH EXISTING ROOF. TO SALVAGE ALL EXISTING CLAY TILES FROM ROOF FOR RE-USE ON MASTER BATH ADDITION. WILL NEED TO CONFIRM ROOF FRAMING/FINISH AND ANY POTENTIAL WATER PENETRATION ISSUES WITH ADJACENT FAMILY ROOM ROOF PRIOR TO REMOVAL.
- REMOVE EXISTING GARAGE DOORS. CONFIRM WITH OWNERS IF TO SALVAGE.
- REMOVE EXISTING EXTERIOR BRICK WALLS. NOTE ANY STRUCTURAL ISSUES. ALERT ARCHITECT. CONSULT WITH STRUCTURAL ENGINEER AS NECESSARY.
- TO CONFIRM W/ STRUCTURAL ENGINEER IF TO REMOVE EXISTING GARAGE SLAB TO ALLOW FOR NEW RAISED SLAB IN NEW GARAGE OR IF EXISTING SLAB CAN REMAIN.

EXTERIOR

- EXISTING HVAC CONDENSING UNIT(S) TO BE RELOCATED - KEEPING ON REAR OF HOUSE. AS REQUIRED FOR NEW MASTER BATH ADDITION. TO CONFIRM WITH OWNERS REGARDING ANY NEW MECHANICAL SYSTEM FOR HOME AND POTENTIAL NEW EXTERIOR UNITS REQUIRED IN ORDER TO PLAN FOR LOCATION AND PADS(S) AS REQUIRED.
- REMOVE EXISTING EXTERIOR LANDSCAPING, PAVERS/GRAVEL AND SITE RETAINING WALLS AS NECESSARY TO ALLOW FOR NEW GARAGE ADDITION. SALVAGE EXISTING SITE WALL STONE FOR RE-USE.
- REMOVE PORTION OF EXISTING ASPHALT PARKING AREA ADJACENT TO BASEMENT STAIRS. CONSULT WITH OWNERS AND/OR LANDSCAPE ARCHITECT TO DETERMINE EXACT LOCATION OF PORTION TO BE REMOVED.

MISCELLANEOUS

- CONFIRM WITH OWNERS IF CHANGES TO BE MADE TO EXISTING MECHANICAL SYSTEM. CONFIRM IF RADIATORS TO REMAIN OR BE REMOVED AND COORDINATE WITH MECHANICAL CONSULTANT AND ARCHITECT IF THERE IS TO BE NEW SYSTEM LAYOUT.
- CONFIRM UPPER LEVEL FLOOR FRAMING CONDITION ONCE CEILING FINISHES REMOVED. CONFIRM IF ANY STRUCTURAL ISSUES AND CONSULT WITH STRUCTURAL ENGINEER AS NECESSARY. NOTE IF ANY POTENTIAL CONFLICTS IN NEW UPPER LEVEL PLUMBING LOCATIONS AND ALERT ARCHITECT.

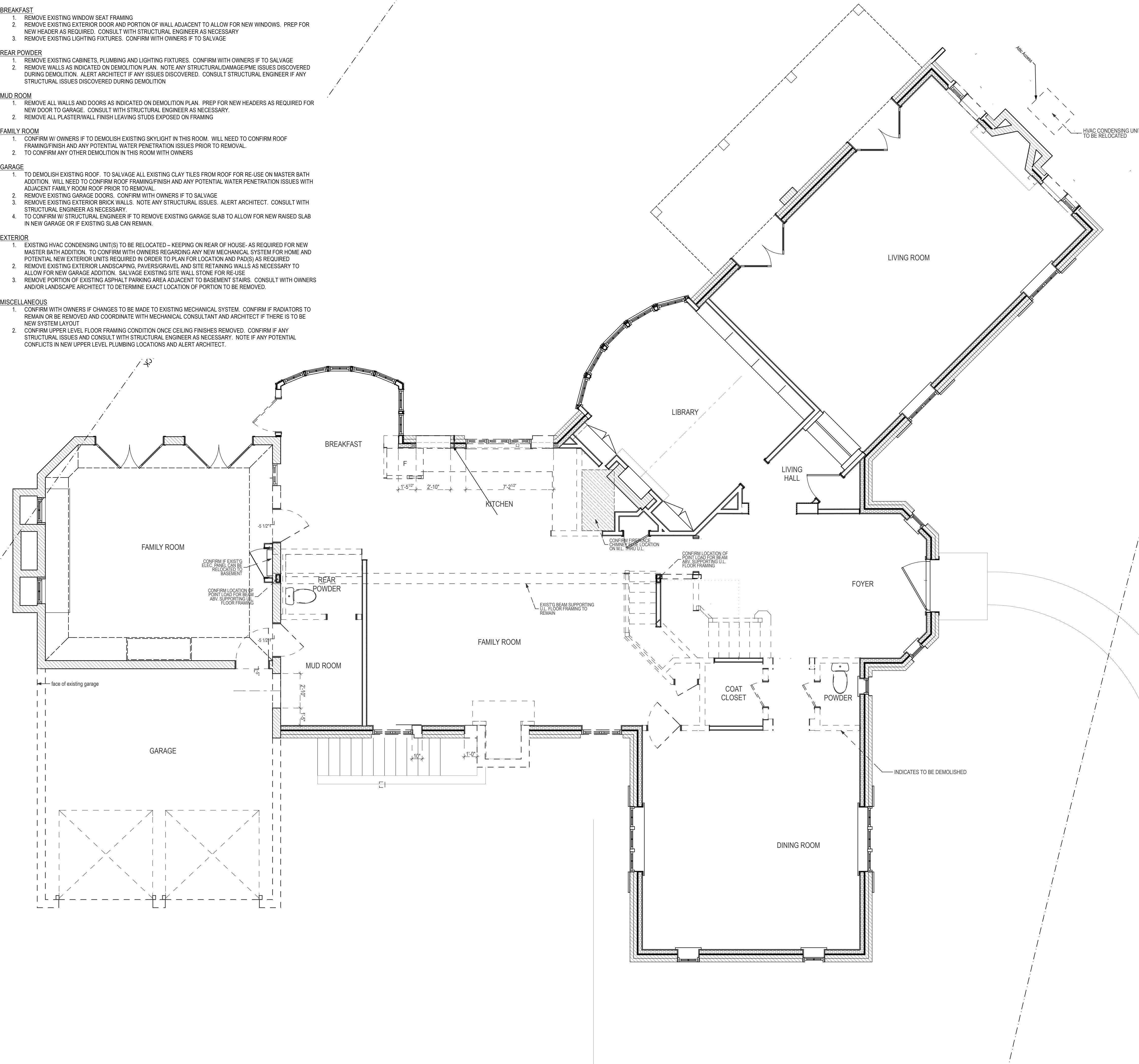

SAMSEL ARCHITECTS
PA.
60 Biltmore Avenue
Asheville, NC 28801
P: 828.253.1124
F: 828.254.7316
www.samselarchitects.com

Professional Engineer Seal for Nathan W. Bryan, License No. 11501, State of North Carolina, expires 12/31/2024.

Professional Engineer Seal for Samsel Architects, PA, License No. 51039, State of North Carolina, expires 12/31/2024.

PROJECT:
Loftin-Skigen Renovation
14 Stuyvesant Rd
Biltmore Forest, NC 28803

SHEET TITLE:
MAIN LEVEL DEMOLITION PLAN

DATE:	DESCRIPTION:
02.23.15	BOARD OF ADJUSTMENT
03.13.15	OWNER REVIEW
04.03.15	OWNER REVIEW
04.16.15	OWNER REVIEW
04.24.15	OWNER REVIEW
05.01.15	PERMIT SET

PROJECT #:
14.41

DRAWN BY: **DKT** CHECKED BY: **JS**

SHEET #:
D-101

COPYRIGHT 2014
SAMSEL ARCHITECTS, P.A.

DEMOLITION NOTES

GENERAL

1. CONFIRM BEARING CAPACITY OF EXISTING STRUCTURE FOR ALL NEW CONSTRUCTION WITH STRUCTURAL ENGINEER.
2. PROVIDE PROTECTIVE MEASURES AS REQUIRED TO PROVIDE FREE AND SAFE PASSAGE FROM OCCUPIED PORTIONS OF BUILDING.
3. PERFORM SELECTIVE DEMOLITION WORK IN A SYSTEMATIC MANNER, USING SUCH METHODS AS REQUIRED TO COMPLETE WORK INDICATED IN THE DRAWINGS IN ACCORDANCE WITH DEMOLITION SCHEDULE AND GOVERNING REGULATIONS.
4. DEMOLISH CONCRETE AND MASONRY IN SMALL SECTIONS. MAKE CLEAN CUTS AT LOCATIONS WHERE EXISTING ELEMENTS ARE TO REMAIN USING POWER-DRIVEN MASONRY SAW OR HAND TOOLS.
5. PROVIDE INTERIOR AND EXTERIOR SHORING, BRACING OR SUPPORTS TO PREVENT MOVEMENT, SETTLEMENT OR COLLAPSE OF EXISTING STRUCTURES. CEASE OPERATIONS AND NOTIFY THE OWNER, OCCUPANTS AND THE ARCHITECT IMMEDIATELY IF SAFETY OF STRUCTURE APPEARS TO BE COMPROMISED. TAKE PRECAUTIONS TO SUPPORT STRUCTURE UNTIL DETERMINATION IS MADE FOR CONTINUING OPERATIONS.
6. PROTECT EXISTING ELEMENTS THAT ARE TO REMAIN FROM DAMAGE DURING THE DEMOLITION PROCESS.
7. PROTECT FLOORS WITH SUITABLE COVERING AS NEEDED.
8. COVER AND PROTECT FURNITURE, EQUIPMENT AND FIXTURES THAT ARE TO REMAIN FROM SOILING OR DAMAGE DURING THE DEMOLITION PROCESS.
9. PROVIDE TEMPORARY WEATHER PROTECTION DURING THE INTERVAL BETWEEN DEMOLITION AND NEW CONSTRUCTION TO ENSURE THAT NO WATER LEAKAGE OR DAMAGE OCCURS TO STRUCTURE OR INTERIOR AREAS OF EXISTING BUILDING.
10. MAINTAIN EXISTING UTILITIES AS INDICATED IN THE DRAWINGS. KEEP IN SERVICE AND PROTECT AGAINST DAMAGE DURING DEMOLITION PROCESS.
11. IF EXISTING MECHANICAL, ELECTRICAL OR STRUCTURAL ELEMENTS CONFLICT WITH THEIR INTENDED FUNCTION OR DESIGN AS SHOWN IN THE DRAWINGS, INVESTIGATE AND MEASURE BOTH NATURE AND EXTENT OF THE CONFLICT AND SUBMIT AN ACCURATE, DETAILED WRITTEN REPORT TO THE ARCHITECT, OWNER OR THEIR REPRESENTATIVE. PENDING RECEIPT OF DIRECTIVE FROM THE OWNER OR THEIR REPRESENTATIVE, REARRANGE SELECTIVE DEMOLITION SCHEDULE AS NECESSARY TO CONTINUE OVERALL JOB PROGRESS WITHOUT DELAY.
12. REPAIR DEMOLITION PERFORMED IN EXCESS OF WHAT IS REQUIRED FOR PLANNED CONSTRUCTION. RETURN STRUCTURES AND SURFACES THAT ARE TO REMAIN TO THEIR PRE-EXISTING CONDITION. REPAIR ADJACENT CONSTRUCTION OR SURFACES DAMAGED DURING THE DEMOLITION PROCESS.
13. CHECK EXISTING CONSTRUCTION FOR PLUMB, LEVEL AND SQUARE IN ALL AREAS TO BE RENOVATED. NOTE AND DESCRIBE ANY DISCREPANCIES TO THE OWNER OR THEIR REPRESENTATIVE FOR REVIEW PRIOR TO BEGINNING NEW CONSTRUCTION.

PLUMBING

1. PERFORM PLUMBING REVIEW WITH PLUMBER TO CONFIRM TIE-IN TO EXISTING PLUMBING LINES AND CONDITION OF EXISTING PLUMBING AND FIXTURES AND PROVIDE RECOMMENDATIONS, PRICING AND SCHEDULING TO THE ARCHITECT, OWNER OR THEIR REPRESENTATIVE.

ELECTRICAL

1. PERFORM ELECTRICAL REVIEW WITH ELECTRICIAN TO REVIEW CURRENT PANEL SIZE AND CONDITION OF EXISTING WIRING AND FIXTURES AND PROVIDE RECOMMENDATIONS, PRICING AND SCHEDULING TO THE ARCHITECT, OWNER OR THEIR REPRESENTATIVE.

MECHANICAL

1. PERFORM MECHANICAL REVIEW WITH HVAC CONTRACTOR TO CONFIRM CONDITION OF EXISTING EQUIPMENT AND LINES. CONFIRM PROPOSED LOCATIONS FOR RELOCATED OR NEW EQUIPMENT, LINES, DUCTS, SUPPLY REGISTERS, RETURN GRILLES AND THERMOSTAT LOCATIONS. PROVIDE RECOMMENDATIONS, PRICING AND SCHEDULING TO THE ARCHITECT, OWNER OR THEIR REPRESENTATIVE.

BEDROOM 1

1. REMOVE INTERIOR WALLS AS INDICATED ON PLAN. NOTE ANY STRUCTURAL ISSUES. ALERT STRUCTURAL ENGINEER.
2. REMOVE EXISTING INTERIOR DOOR. CONFIRM WITH OWNERS IF TO SALVAGE.

BATH 1

1. REMOVE ALL PLUMBING, ELECTRICAL FIXTURES AND ACCESSORIES. CONFIRM WITH OWNERS IF TO SALVAGE.
2. REMOVE ALL INTERIOR WALLS AS INDICATED ON DEMOLITION PLAN. NOTE ANY STRUCTURAL ISSUES. ALERT STRUCTURAL ENGINEER.
3. REMOVE ALL WALL FINISHES ON WALLS TO REMAIN. EXPOSURE WALL STUDS TO ALLOW FOR NEW PLUMBING, ELECTRICAL AND INSULATION FOR NEW BATHROOM DESIGN.
4. REMOVE FLOOR FINISHES AND NOTE CONDITION OF EXISTING FLOOR. IF FRAMING HAS BEEN COMPROMISED UNDER EXISTING BATH, ALERT ARCHITECT AND STRUCTURAL ENGINEER. MAY REQUIRE RE-FRAMING.
5. REMOVE EXISTING INTERIOR DOOR. CONFIRM WITH OWNERS IF TO SALVAGE.

CLOSET 1A AND 1B

1. REMOVE ALL INTERIOR WALLS AS INDICATED ON DEMOLITION PLAN. NOTE ANY STRUCTURAL ISSUES. ALERT STRUCTURAL ENGINEER.
2. REMOVE EXISTING INTERIOR DOOR(S). CONFIRM WITH OWNERS IF TO SALVAGE.

STAIR HALL

1. REMOVE EXISTING RAILING AND BALUSTERS AS INDICATED ON DEMOLITION PLAN.
2. COORDINATE REMOVAL OF STAIRS AND FLOORING WITH STRUCTURAL ENGINEER. MAY REQUIRE TEMPORARY BRACING TO SUPPORT UPPER LEVEL WHILE NEW UPPER LEVEL FLOOR FRAMING INSTALLED. CONSULT WITH STRUCTURAL ENGINEER W/ ANY QUESTIONS RELATIVE TO LOAD, OPENING IN FLOOR, SIZING OF STRUCTURAL MEMBERS ETC.
3. COORDINATE REMOVAL OF EXISTING STAIRS WITH PROVISION FOR TEMPORARY STAIRS AS MAY BE REQUIRED TO MAINTAIN ACCESS TO UPPER LEVEL DURING CONSTRUCTION.
4. REMOVE EXISTING INTERIOR WALLS AS INDICATED ON DEMOLITION PLAN. NOTE ANY STRUCTURAL ISSUES. ALERT STRUCTURAL ENGINEER.
5. REMOVE ALL LIGHTING FIXTURES. CONFIRM WITH OWNERS IF TO SALVAGE.

BEDROOM 2

1. REMOVE EXISTING INTERIOR DOORS AS INDICATED ON PLAN. CONFIRM WITH OWNERS IF TO SALVAGE.
2. REMOVE EXISTING LTG FIXTURES. CONFIRM WITH OWNERS IF TO SALVAGE.

CLOSET 2

1. REMOVE INTERIOR WALLS AND ALL FINISHES AND ACCESSORIES INDICATED ON DEMOLITION PLAN.

BATH 2/3

1. REMOVE ALL EXISTING PLUMBING FIXTURES, ELECTRICAL FIXTURES AND ACCESSORIES. CONFIRM WITH OWNERS IF TO SALVAGE.
2. REMOVE INTERIOR WALLS AND FINISHES AS INDICATED ON DEMOLITION PLAN. EXPOSE ALL WALL FRAMING.
3. REMOVE FLOOR FINISHES AND NOTE CONDITION OF EXISTING FLOOR. IF FRAMING HAS BEEN COMPROMISED UNDER EXISTING BATH, ALERT ARCHITECT AND STRUCTURAL ENGINEER. MAY REQUIRE RE-FRAMING.
4. REMOVE EXISTING INTERIOR DOORS AS INDICATED ON PLAN. CONFIRM WITH OWNERS IF TO SALVAGE.

BEDROOM 3

1. REMOVE EXISTING INTERIOR WALLS AS INDICATED ON DEMOLITION PLAN. NOTE ANY STRUCTURAL ISSUES. ALERT STRUCTURAL ENGINEER.
2. REMOVE EXISTING INTERIOR DOORS AS INDICATED ON PLAN. CONFIRM WITH OWNERS IF TO SALVAGE.
3. REMOVE EXISTING LTG FIXTURES. CONFIRM WITH OWNERS IF TO SALVAGE.

BEDROOM 4

1. REMOVE EXISTING INTERIOR WALLS AS INDICATED ON DEMOLITION PLAN. NOTE ANY STRUCTURAL ISSUES. ALERT STRUCTURAL ENGINEER.
2. REMOVE EXISTING INTERIOR DOORS AS INDICATED ON PLAN. CONFIRM WITH OWNERS IF TO SALVAGE.
3. REMOVE EXISTING LTG FIXTURES. CONFIRM WITH OWNERS IF TO SALVAGE.

BATHROOM 5/6

1. REMOVE ALL EXISTING PLUMBING FIXTURES, ELECTRICAL FIXTURES AND ACCESSORIES. CONFIRM WITH OWNERS IF TO SALVAGE.
2. REMOVE INTERIOR WALLS AND FINISHES AS INDICATED ON DEMOLITION PLAN. EXPOSE ALL WALL FRAMING.
3. REMOVE FLOOR FINISHES AND NOTE CONDITION OF EXISTING FLOOR. IF FRAMING HAS BEEN COMPROMISED UNDER EXISTING BATH, ALERT ARCHITECT AND STRUCTURAL ENGINEER. MAY REQUIRE RE-FRAMING.
4. REMOVE EXISTING INTERIOR DOORS AS INDICATED ON PLAN. CONFIRM WITH OWNERS IF TO SALVAGE.

BEDROOM 5

1. REMOVE EXISTING INTERIOR WALLS AS INDICATED ON DEMOLITION PLAN. NOTE ANY STRUCTURAL ISSUES. ALERT STRUCTURAL ENGINEER.
2. REMOVE EXISTING INTERIOR DOORS AS INDICATED ON PLAN. CONFIRM WITH OWNERS IF TO SALVAGE.
3. REMOVE EXISTING LTG FIXTURES. CONFIRM WITH OWNERS IF TO SALVAGE.

BEDROOM 6

1. REMOVE EXISTING INTERIOR WALLS AS INDICATED ON DEMOLITION PLAN. NOTE ANY STRUCTURAL ISSUES. ALERT STRUCTURAL ENGINEER.
2. REMOVE EXISTING INTERIOR DOORS AS INDICATED ON PLAN. CONFIRM WITH OWNERS IF TO SALVAGE.
3. REMOVE EXISTING LTG FIXTURES. CONFIRM WITH OWNERS IF TO SALVAGE.

REAR STAIR/LAUNDRY

1. REMOVE EXISTING RAILING AND BALUSTERS AS INDICATED ON DEMOLITION PLAN.
2. COORDINATE REMOVAL OF STAIRS AND FLOORING WITH STRUCTURAL ENGINEER. MAY REQUIRE TEMPORARY BRACING TO SUPPORT UPPER LEVEL WHILE NEW UPPER LEVEL FLOOR FRAMING INSTALLED. CONSULT WITH STRUCTURAL ENGINEER W/ ANY QUESTIONS RELATIVE TO LOAD AND SIZING OF STRUCTURAL MEMBERS ETC.
3. COORDINATE REMOVAL OF EXISTING STAIRS WITH PROVISION FOR TEMPORARY STAIRS AS MAY BE REQUIRED TO MAINTAIN ACCESS TO UPPER LEVEL DURING CONSTRUCTION.
4. REMOVE EXISTING INTERIOR WALLS AS INDICATED ON DEMOLITION PLAN. NOTE ANY STRUCTURAL ISSUES. ALERT STRUCTURAL ENGINEER.
5. REMOVE EXISTING INTERIOR DOORS AS INDICATED ON PLAN. CONFIRM WITH OWNERS IF TO SALVAGE.
6. REMOVE EXISTING LTG FIXTURES. CONFIRM WITH OWNERS IF TO SALVAGE.

REAR HALL

1. REMOVE EXISTING INTERIOR WALLS AS INDICATED ON DEMOLITION PLAN. NOTE ANY STRUCTURAL ISSUES AND CONFIRM LOCATION OF EXISTING FLUE GOING UP BEHIND HALL WALL. NOTE IF ANY STRUCTURAL ISSUES OR CONCERNS.
2. REMOVE EXISTING INTERIOR DOORS AS INDICATED ON PLAN. CONFIRM WITH OWNERS IF TO SALVAGE.
3. REMOVE EXISTING LTG FIXTURES. CONFIRM WITH OWNERS IF TO SALVAGE.

MISCELLANEOUS

1. CONFIRM WITH OWNERS IF TO REPLACE ALL UPPER LEVEL WINDOWS WITH NEW WINDOWS. IF SO, CONFIRM WINDOW MANUFACTURER AND CONSULT WITH WINDOW REPRESENTATIVE TO DETERMINE REPLACEMENT WINDOW SIZING AND DETAILS. IF ANY CHANGES IN SIZES DESIRED, CONFIRM WITH STRUCTURAL ENGINEER AS NECESSARY FOR ANY ADDITIONAL HEADER/LOAD SIZING INFORMATION REQUIRED.

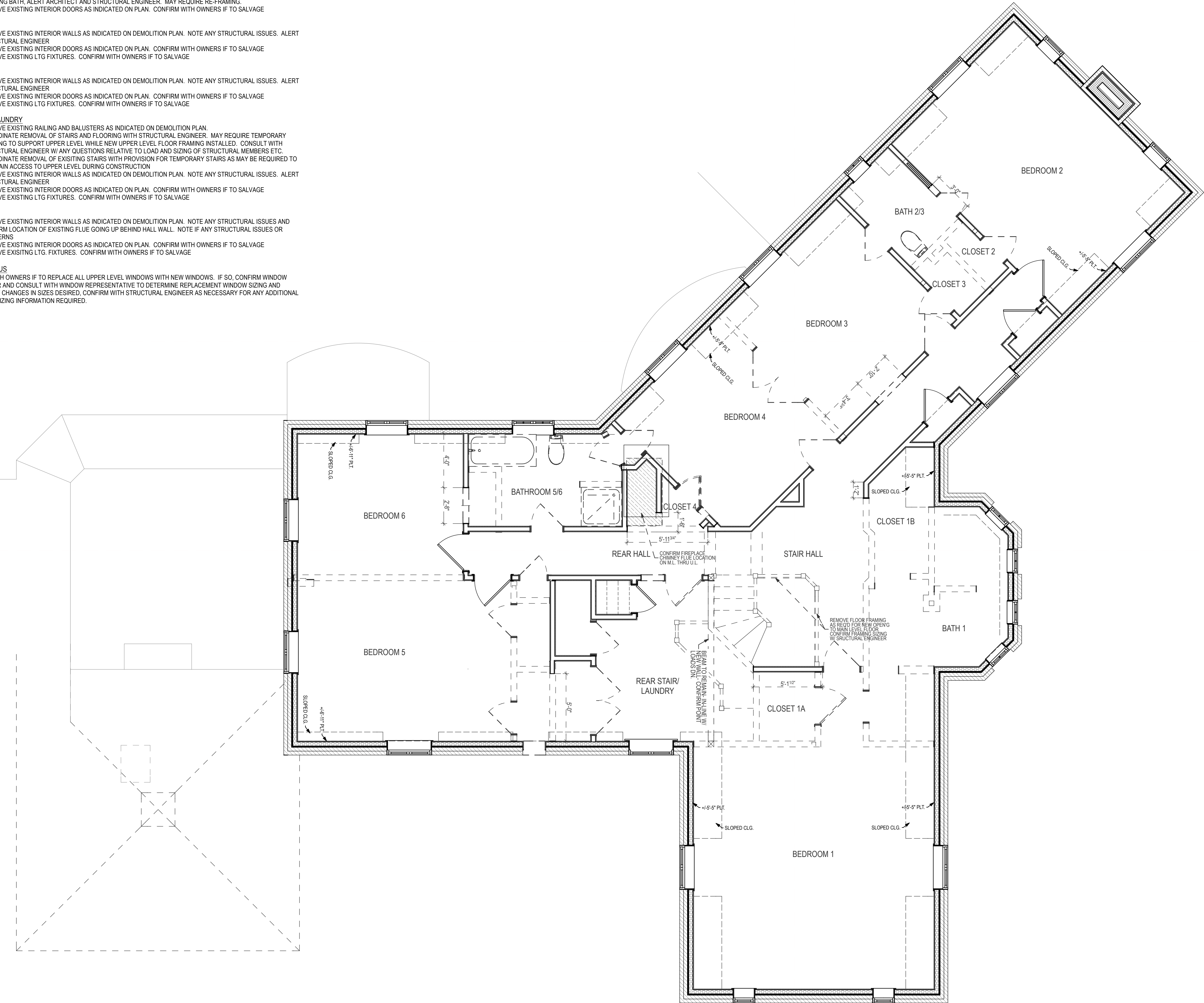

SAMSEL ARCHITECTS
PA.
60 Biltmore Avenue
Asheville, NC 28801
P: 828.253.1124
F: 828.254.7316
www.samselarchitects.com

Professional Engineer Seal for Nathan W. Bryan, License No. 11501, State of North Carolina, expires 12/31/2024.

Professional Engineer Seal for Samsel Architects, License No. 51039, State of North Carolina, expires 12/31/2024.

PROJECT:
Loftin-Skigen Renovation

14 Stuyvesant Rd
Biltmore Forest, NC 28803

SHEET TITLE:
UPPER LEVEL DEMOLITION PLAN

DATE:	DESCRIPTION:
02.23.15	BOARD OF ADJUSTMENT
03.13.15	OWNER REVIEW
04.03.15	OWNER REVIEW
04.16.15	OWNER REVIEW
04.24.15	OWNER REVIEW
05.01.15	PERMIT SET

PROJECT #:
14.41

DRAWN BY: **DKT** CHECKED BY: **JS**

SHEET #:
D-102

COPYRIGHT 2014
SAMSEL ARCHITECTS, P.A.

ELECTRICAL NOTES

GENERAL

1. INSTALLATION TO CONFORM WITH REQUIREMENTS OF N.E.C. AS ADAPTED AND INTERPRETED BY THE AUTHORITY HAVING JURISDICTION.
2. SUBCONTRACTOR(S) ARE RESPONSIBLE FOR REPAIRING OR REPLACING ANY DAMAGE THEY INFLICT TO WORK BY OTHERS.
3. CONFIRM LOCATIONS OF ANY DEVICES, FIXTURES, ETC. NOT SHOWN IN THE DRAWINGS WITH ARCHITECT PRIOR TO INSTALLATION.
4. HEIGHT DIMENSIONS ARE ABOVE FINISHED FLOOR (A.F.F.) AND TO CENTERLINE OF BOX. CONFIRM FLOOR FINISH THICKNESSES WITH GENERAL CONTRACTOR.
5. DO NOT ASSUME LEVEL CONSTRUCTION. ALL BOXES DESIGNED TO BE AT THE SAME HEIGHT SHALL BE SET LEVEL BY ELECTRICIAN.
6. ELECTRICIAN TO CONFIRM ALL HVAC, APPLIANCE AND EQUIPMENT WIRING REQUIREMENTS WITH GENERAL CONTRACTOR AND RELATED SUB-CONTRACTORS.

LOCATION

1. NAIL UP BOXES FOR FIXTURES AND DEVICES (SWITCHES, RECEPTACLES, ETC.) IN EACH ROOM FOR ARCHITECT'S APPROVAL PRIOR TO WIRING.
2. WHERE ELECTRICAL DEVICES ARE SHOWN NEAR OPENINGS AND THE EXPOSED, FINISHED WALL SURFACE IS GREATER THAN 18", SET SO THAT THE COVER PLATE IS ± 1" TO ADJACENT FINISHED TRIM. WHERE THE EXPOSED, FINISHED WALL SURFACE ADJACENT TO OPENINGS IS 18" OR LESS OR WHERE DEVICES ARE SHOWN CENTERED IN WALLS, FLOORS AND CEILINGS, SET SO AS TO BE CENTERED ON EXPOSED, FINISHED SURFACE. CONFIRM FINISHES AND TRIM TYPES PRIOR TO INSTALLATION. SEE ELECTRICAL DIAGRAMS.
3. CENTER SWITCHES, VOLUME AND LIGHTING CONTROLS, AND SIMILAR DEVICES AT 40" A.F.F. UNLESS NOTED OTHERWISE. STACK MULTIPLE DEVICES WITH LOWEST AT 40" A.F.F. AND SPACED VERTICALLY AT 6" CENTER TO CENTER. SEE ELECTRICAL DIAGRAMS.
4. PLACE WALL MOUNTED RECEPTACLES AND DATA/COMMUNICATION JACKS AT THE FOLLOWING HEIGHTS UNLESS NOTED OTHERWISE (SEE ELECTRICAL DIAGRAMS):
 - TYPICAL FOR MAIN LEVEL: HORIZONTAL ORIENTATION, CENTERED VERTICALLY IN BASEBOARD
 - TYPICAL FOR ALL OTHER LEVELS: 16" A.F.F.
 - ABOVE COUNTERS WITH TILE BACKSPASH: USE METAL 'OLD WORK' TYPE BOX IN HORIZONTAL ORIENTATION. SET IN FIRST TILE COURSE (AFTER COURSING HAS BEEN ESTABLISHED) AND CENTERED HORIZONTALLY AND VERTICALLY IN TILE.
 - ABOVE COUNTER WITH OTHER BACKSPASH TYPES: HORIZONTAL ORIENTATION, CENTERED VERTICALLY IN BACKSPASH.
 - ABOVE COUNTER WITH NO BACKSPASH: HORIZONTAL ORIENTATION, ± 2" ABOVE TOP OF COUNTER.
5. WHERE MULTIPLE DEVICES ARE SHOWN IN DIRECT PROXIMITY TO EACH OTHER AND LOCATED AT DIFFERENT HEIGHTS, THEIR CENTERLINES ARE TO ALIGN VERTICALLY.
6. WHERE MULTIPLE DEVICES ARE SHOWN INDIRECT PROXIMITY AND LOCATED AT THE SAME HEIGHT, SPACE BOXES 1 1/2" SO AS TO LEAVE A ± 1/2" GAP BETWEEN COVER PLATES. SEE ELECTRICAL DIAGRAMS.
7. PULL WIRES FOR WALL MOUNTED SCONES AT HEIGHT INDICATED IN THE DRAWINGS WITH 24" MIN. PIGTAIL. FINAL LOCATION TO BE DETERMINED IN FIELD WITH ARCHITECT AND/OR INTERIOR DESIGNER PRIOR TO FIXTURE INSTALLATION.
8. FLUORESCENT FIXTURES IN MECHANICAL, STORAGE ROOMS, ETC. TO BE SUSPENDED WITH CHAINS AT 8'-0" A.F.F.; CONFIRM HEIGHT WITH ARCHITECT PRIOR TO INSTALLATION.
9. IF NOT INDICATED IN THE DRAWINGS, HEIGHTS OF EXTERIOR WALL MOUNTED AND FLOOD LIGHTS TO BE DETERMINED IN FIELD WITH ARCHITECT PRIOR TO INSTALLATION.
10. MOUNT ALL FLUORESCENT FIXTURES IN CLOSETS HORIZONTALLY ON WALL 8" ABOVE DOOR OPENINGS AND CENTERED OVER DOOR.
11. UNDER AND OVER CABINET LIGHTS TO BE DIRECTLY WIRED AT LOCATIONS AS SHOWN IN THE DRAWINGS. SEE ELECTRICAL DIAGRAMS.
12. REVIEW ELECTRICAL DIAGRAMS, INTERIOR ELEVATIONS AND REFLECTED CEILING PLANS FOR ADDITIONAL INFORMATION ON PLACEMENT OF ALL ELECTRICAL FIXTURES AND DEVICES PRIOR TO INSTALLATION.
13. FINAL MOUNTING HEIGHT OF ALL EXTERIOR FIXTURES AND DEVICES SHALL BE ADJUSTED TO ALIGN WITH CENTER LINES OF EXTERIOR FINISH MATERIAL AS DETERMINED BY MATERIAL COURSING.
14. REVIEW ELECTRICAL REQUIREMENTS AND MANUFACTURER'S SPECIFICATIONS FOR ALL APPLIANCES AND CONFIRM FINAL LOCATION OF ASSOCIATED ELECTRICAL DEVICES WITH ARCHITECT.
15. CONFIRM FINAL LOCATION OF ALARM SYSTEM CONTROLS AND DEVICES WITH GENERAL CONTRACTOR AND ARCHITECT PRIOR TO INSTALLATION.

COMMUNICATION

1. PRE-WIRE AND INSTALL DATA/COMMUNICATION JACKS AND WIRING. SET AT THE SAME HEIGHT AND DIRECTION AS WALL MOUNTED RECEPTACLES UNLESS NOTED OTHERWISE.
2. ALL DATA/COMMUNICATION WIRING TO BE TWISTED PAIR CAT6 CABLE AND/OR RG6 COAXIAL CABLE, WITH HOME RUNS PULLED TO A CENTRAL LOCATION. CONFIRM LOCATION WITH ARCHITECT PRIOR TO WIRING.
3. CONFIGURATION OF ALL DATA/COMMUNICATION JACKS (I.E. TELEPHONE, ETHERNET, CABLE) TO BE DETERMINED BY LOW VOLTAGE WIRING CONTRACTOR OR ELECTRICIAN AND REVIEWED WITH ARCHITECT PRIOR TO INSTALLATION.
4. THERMOSTATS (BY HVAC CONTRACTOR) TO BE CENTERED ABOVE SWITCHES/ DIMMERS WHERE THEY ARE SHOWN IMMEDIATELY ADJACENT TO SWITCHES/ DIMMERS.
5. CENTER THERMOSTATS AT 60" A.F.F. UNLESS NOTED OTHERWISE.
6. COORDINATE WIRING OF ALL HVAC EQUIPMENT WITH MECHANICAL CONTRACTOR.
7. CENTER DOORBELL SWITCHES AT 36" A.F.F. U.N.D.

MISCELLANEOUS

1. CONFIRM COLOR AVAILABILITY OF ALL SWITCHES, RECEPTACLES, COVER PLATES, RECESSED LIGHT TRIM RINGS AND BAFFLES WITH ARCHITECT AND INTERIOR DESIGNER PRIOR TO ORDERING. IDENTIFY ANY COLORS OF DEVICES NOT AVAILABLE AS SPECIFIED AND TRANSMIT TO ARCHITECT IN WRITING.
2. ELECTRICIAN TO INSTALL ALL "BY OWNER" FIXTURES.
3. PROVIDE 'KEYLESS' SWITCHED FIXTURES IN ATTICS AS PER CODE REQUIREMENTS.
4. PROVIDE SOLID BLOCKING FOR ALL CEILING FANS & CEILING FIXTURES TO SUPPORT 150# PER FIXTURE MIN.
5. PROVIDE 130 VOLT BULBS WHERE POSSIBLE.
6. CONFIRM ALL TRANSFORMER LOCATIONS WITH ARCHITECT.
7. ALL FLUORESCENT BULBS IN HABITABLE SPACES TO BE WARM WHITE OR 3000K.

ELECTRICAL SYMBOLS LEGEND

	SWITCH - SINGLE POLE		PANELBOARD
	SWITCH - THREE WAY		JUNCTION BOX - CEILING
	SWITCH - FOUR WAY		JUNCTION BOX - WALL
	SWITCH - WITH DIMMER		SMOKE DETECTOR - CEILING MOUNTED
	SWITCH - FAN CONTROL		SMOKE DETECTOR - WALL MOUNTED
	SWITCH - AUDIO VOLUME CONTROL		HEAT DETECTOR
	SWITCH - ILLUMINATED		HEAT DETECTOR - WALL MOUNTED
	110V DUPLEX RECEPTACLE		THERMOSTAT
	110V DUPLEX RECEPTACLE - USB OUTLET		DOORBELL PUSHBUTTON
	110V DUPLEX RECEPTACLE - SWITCHED		DOORBELL CHIME
	110V DUPLEX RECEPTACLE - HALF SWITCHED		CEILING MOUNTED SPEAKER
	110V DUPLEX RECEPTACLE - GROUND FAULT CIRCUIT INTERRUPTER		WALL MOUNTED SPEAKER
	110V DUPLEX RECEPTACLE - FLOOR OUTLET		SOUND SYSTEM - CENTRAL CONTROL
	110V DUPLEX RECEPTACLE - WATERPROOF		ALARM SYSTEM KEYPAD
	110V QUADRIPEX RECEPTACLE		LIGHTING CONTROL SYSTEM KEYPAD
	220V RECEPTACLE		MOTION SENSOR
	RECESSED CLOCK RECEPTACLE		SECURITY CAMERA
	DATA/ COMMUNICATIONS JACK		CARD READER
	CEILING MOUNTED LIGHT FIXTURE - FLUSH		ELECTRONIC DOOR STRIKE
	CEILING MOUNTED LIGHT FIXTURE - PENDANT		WIRELESS ACCESS
	WALL MOUNTED LIGHT FIXTURE		CEILING FAN
	WALL MOUNTED LAMP		EXHAUST FAN
	RECESSED LIGHT FIXTURE		
	FLUORESCENT LIGHT FIXTURE		
	UNDER CABINET LIGHTING		
	LIGHT TRACK		

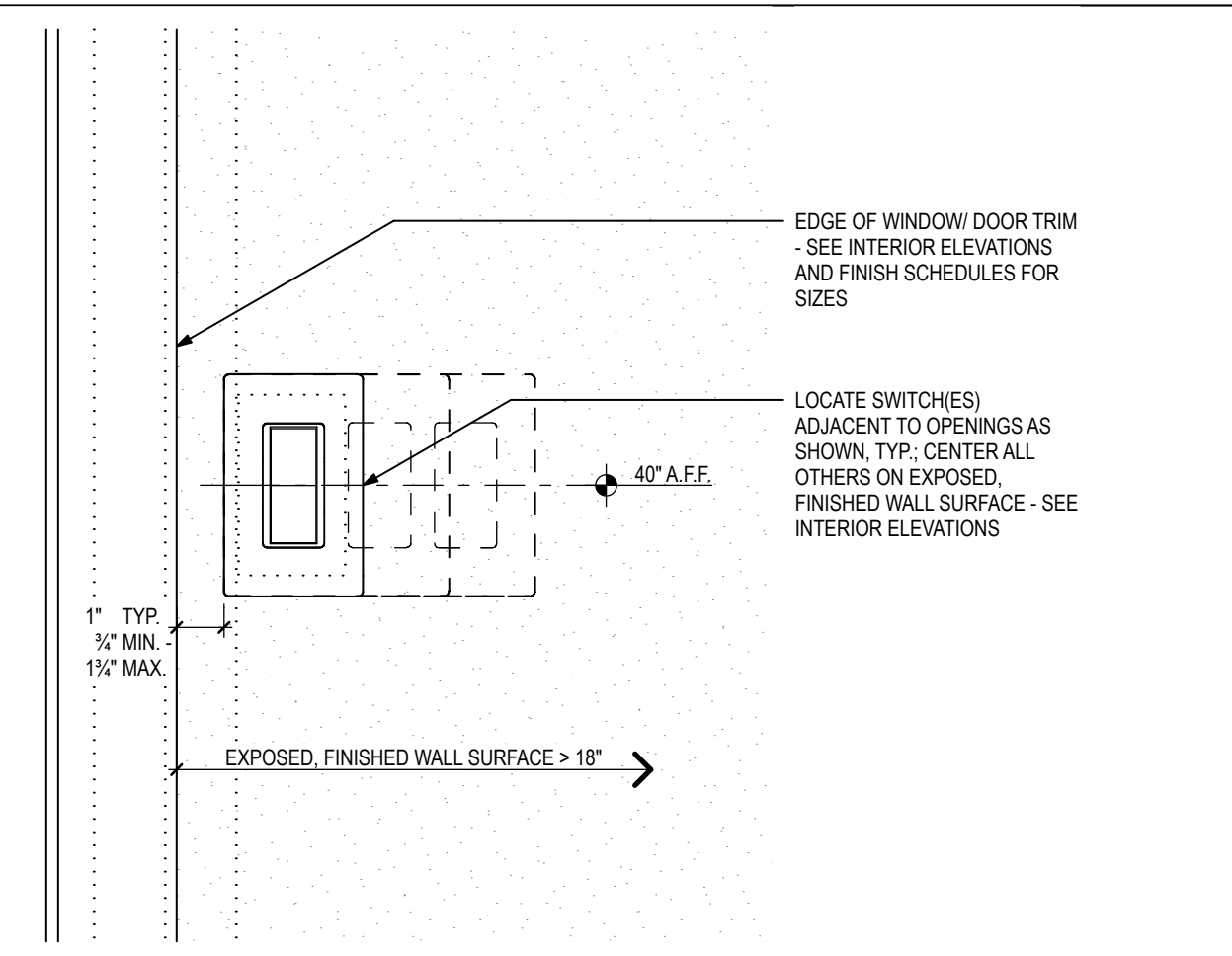

TYPICAL WALL SWITCH LOCATION

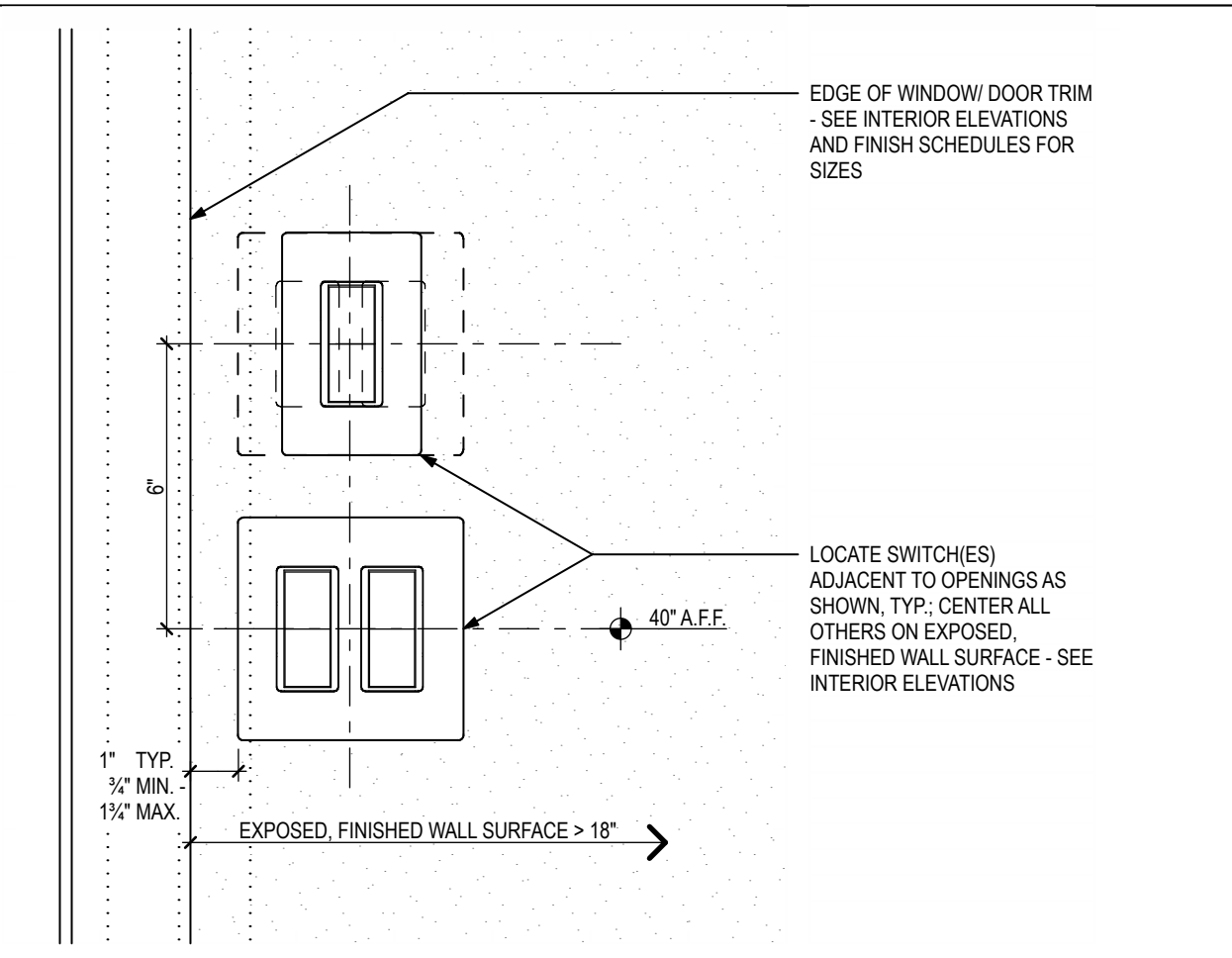

WALL SWITCH STACKING DIAGRAM

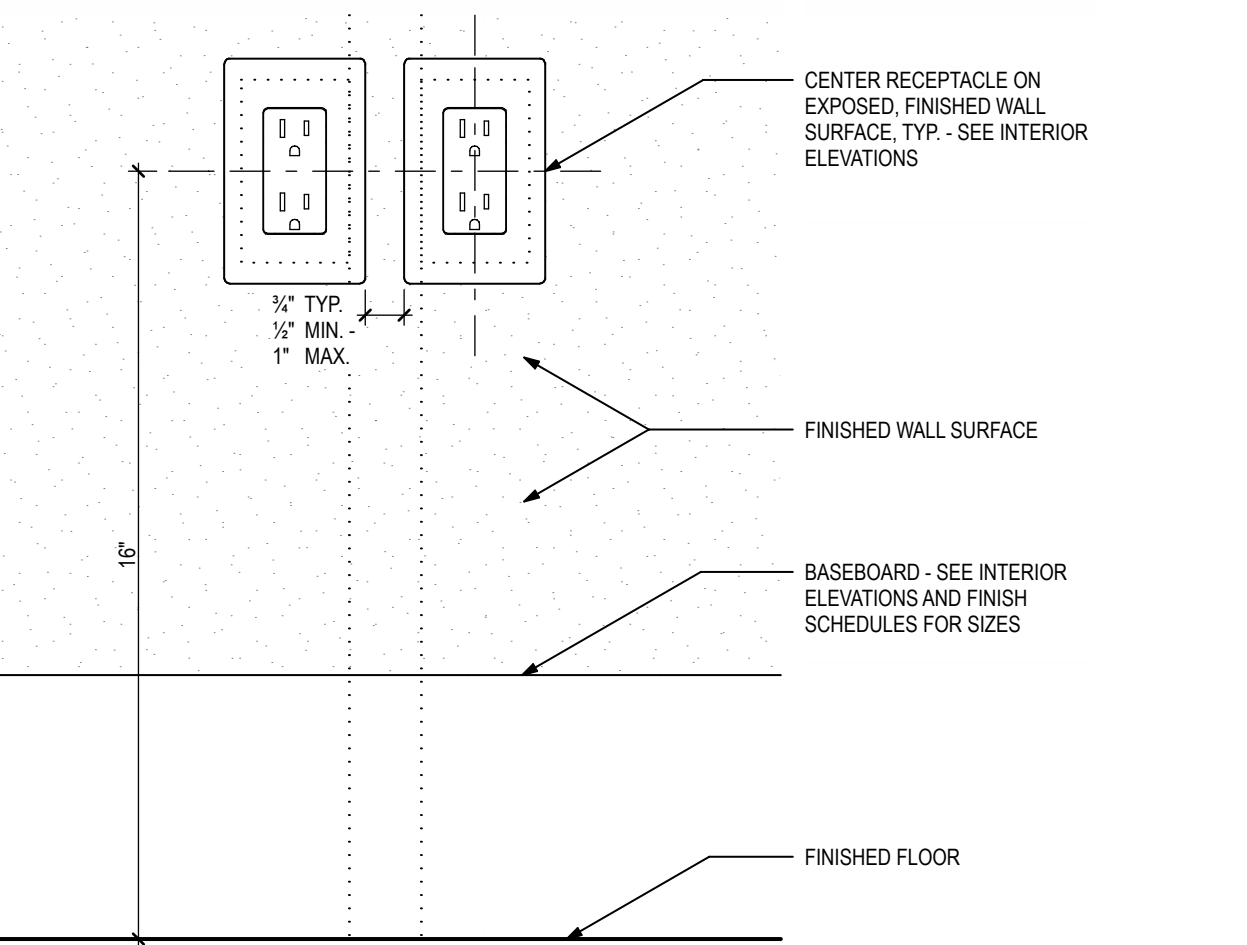

TYPICAL RECEPTACLE LOCATION

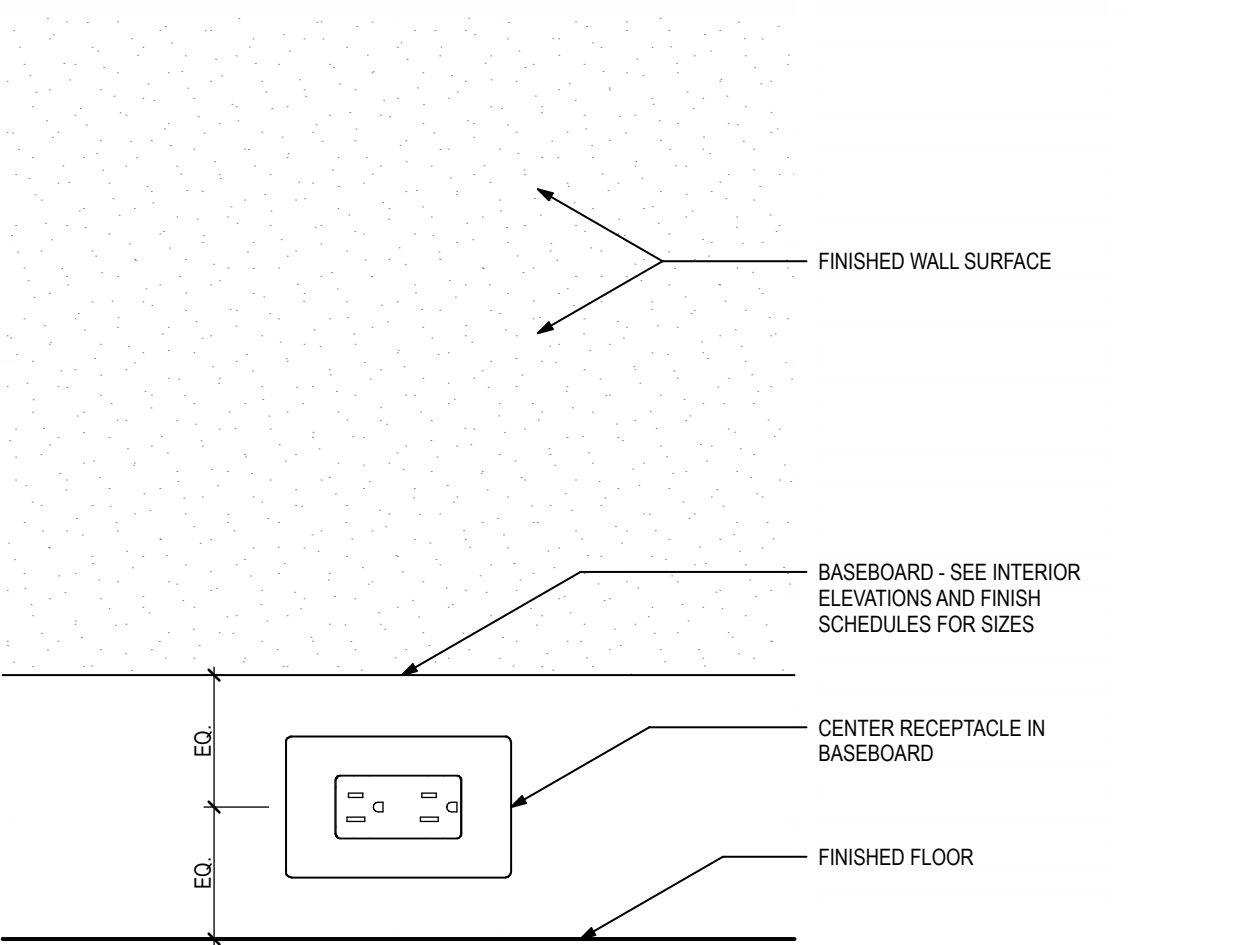

BASEBOARD RECEPTACLE LOCATION (TYP. @ MAIN LEVEL)

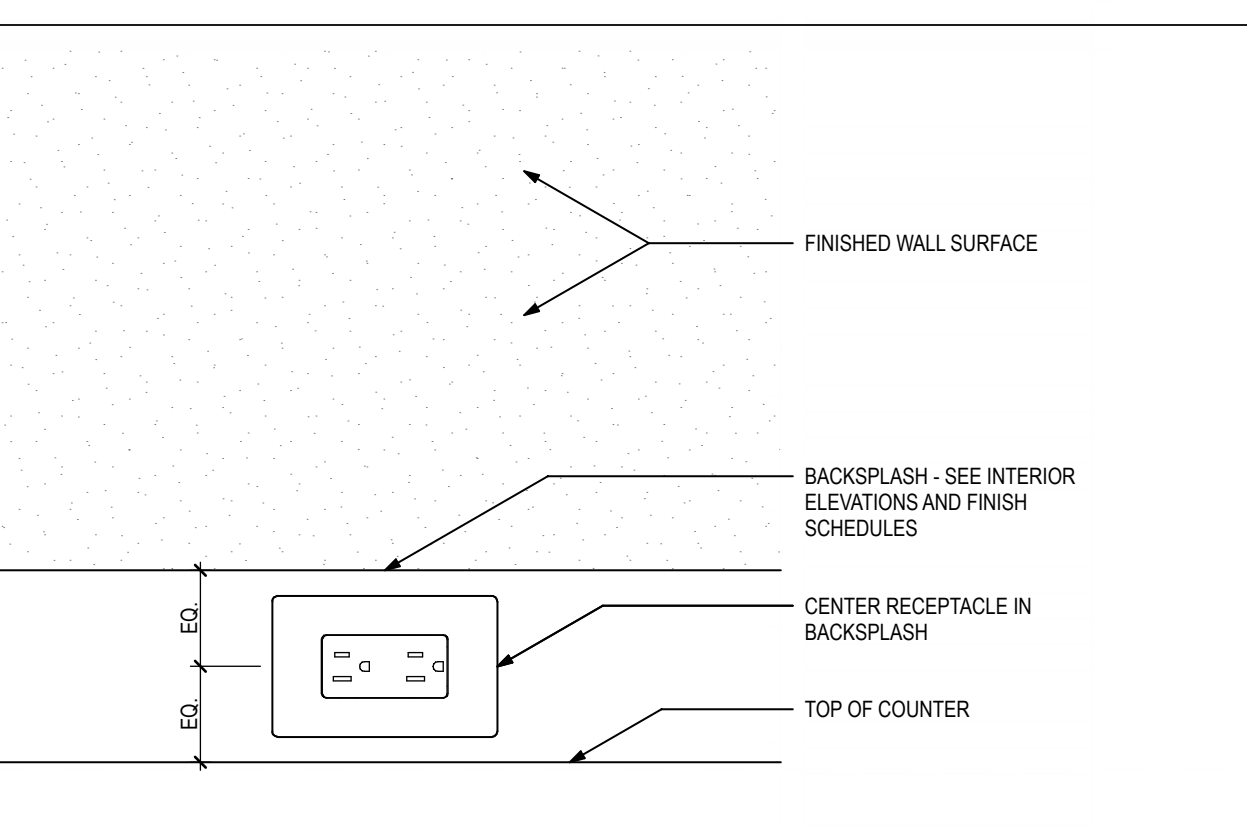

RECEPTACLE LOCATION AT COUNTER WITH STANDARD BACKSPASH (TYP. @ LAUNDRY & BATH)

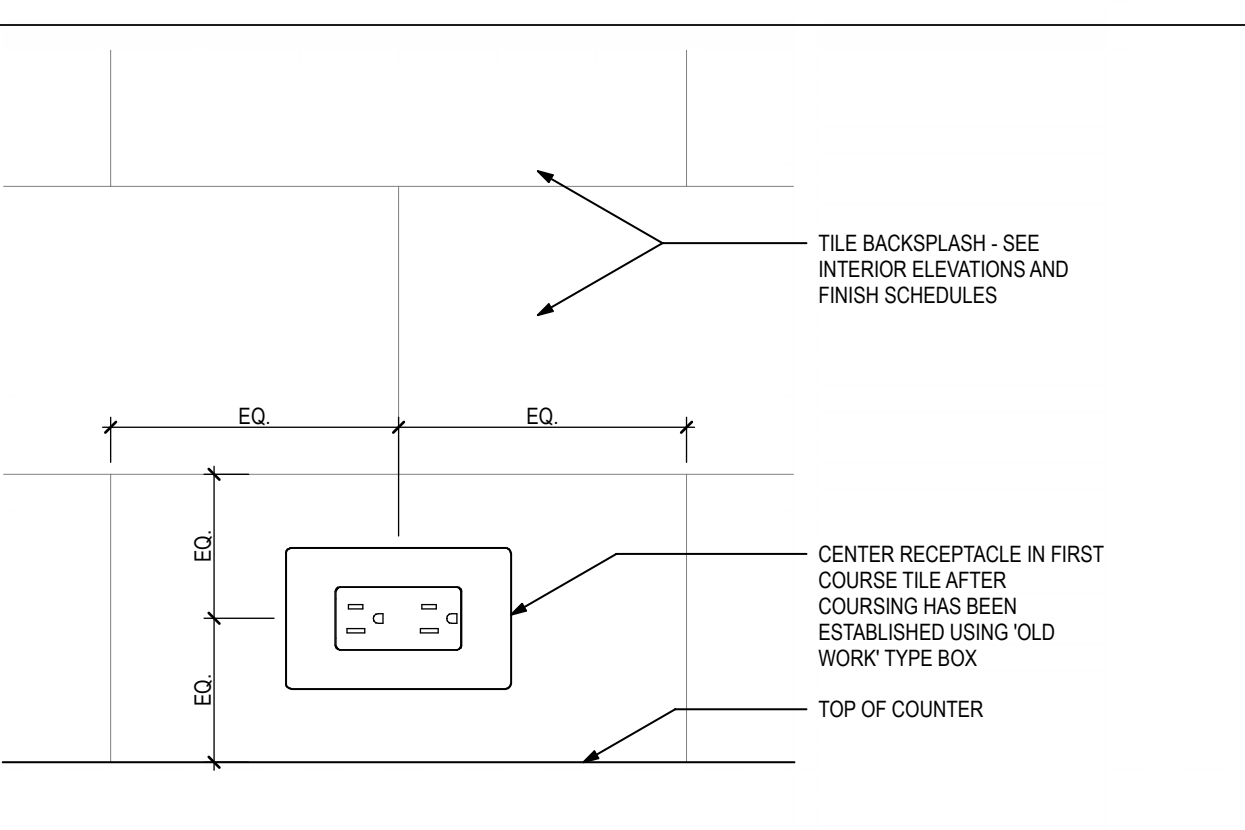

RECEPTACLE LOCATION AT COUNTER WITH TILE BACKSPASH (TYP. @ KITCHEN)

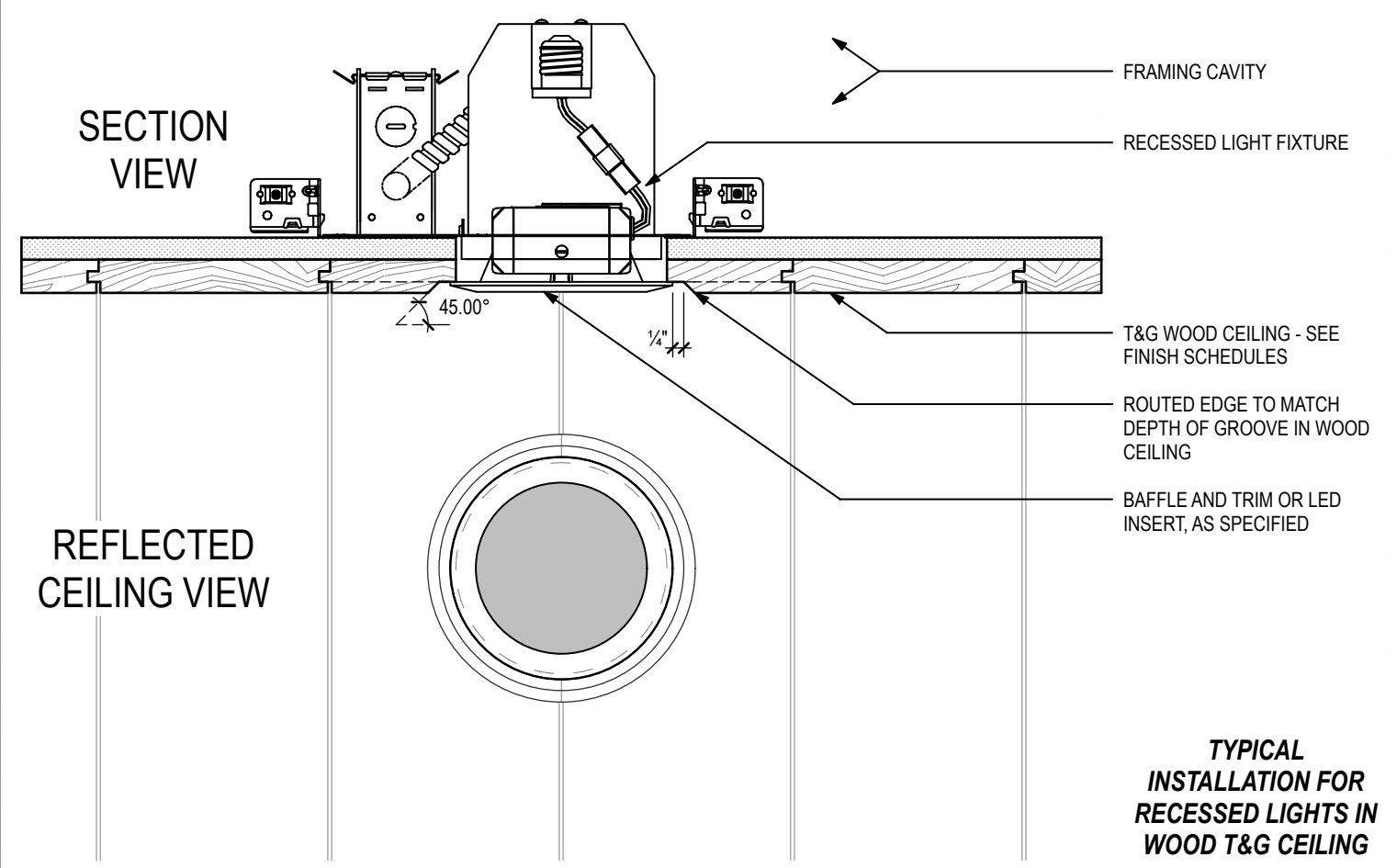

RECESSED LIGHTING IN WOOD CEILINGS

SCALE: 3" = 1'-0"

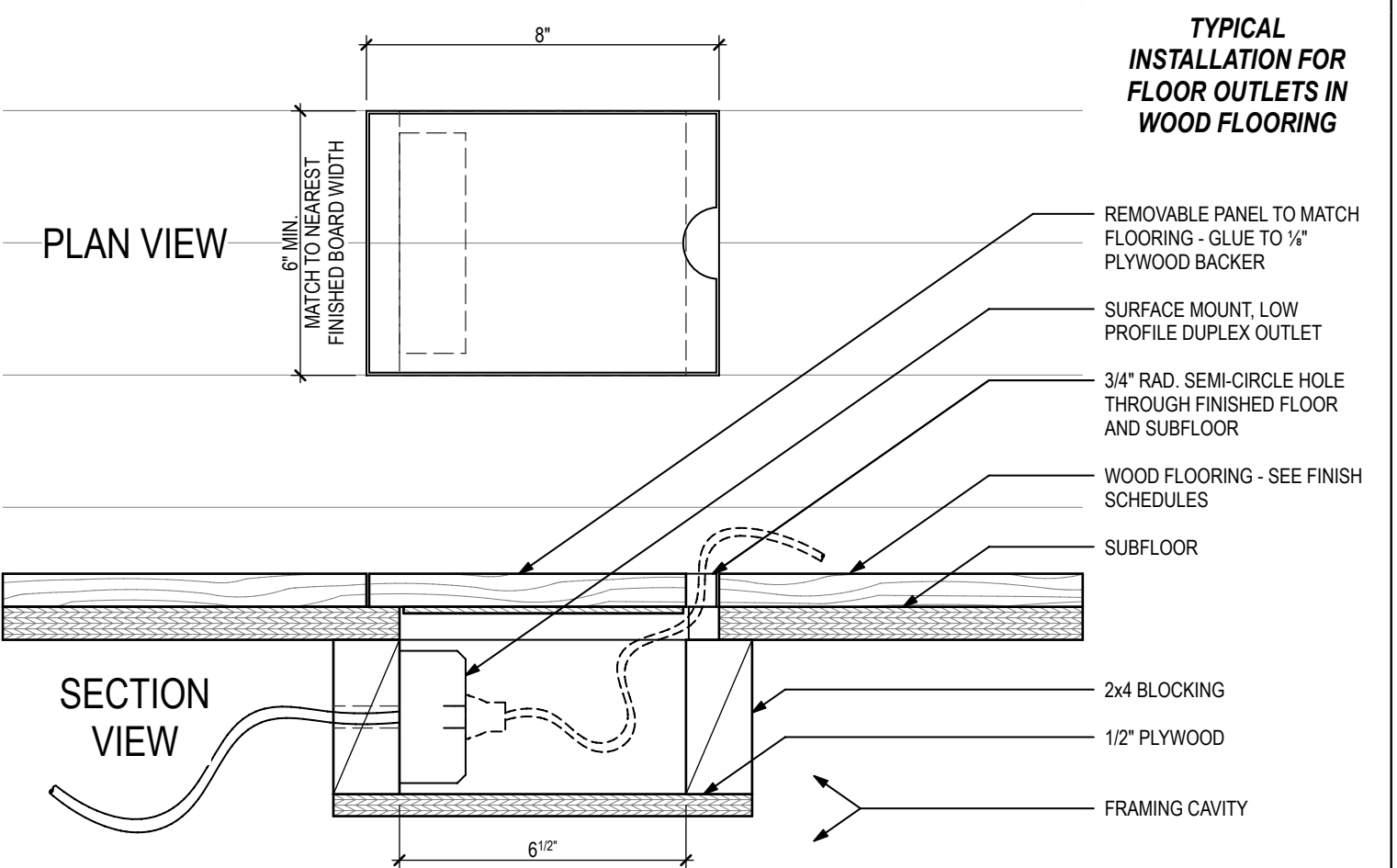

RECESSED FLOOR RECEPTACLE

SCALE: 3" = 1'-0"

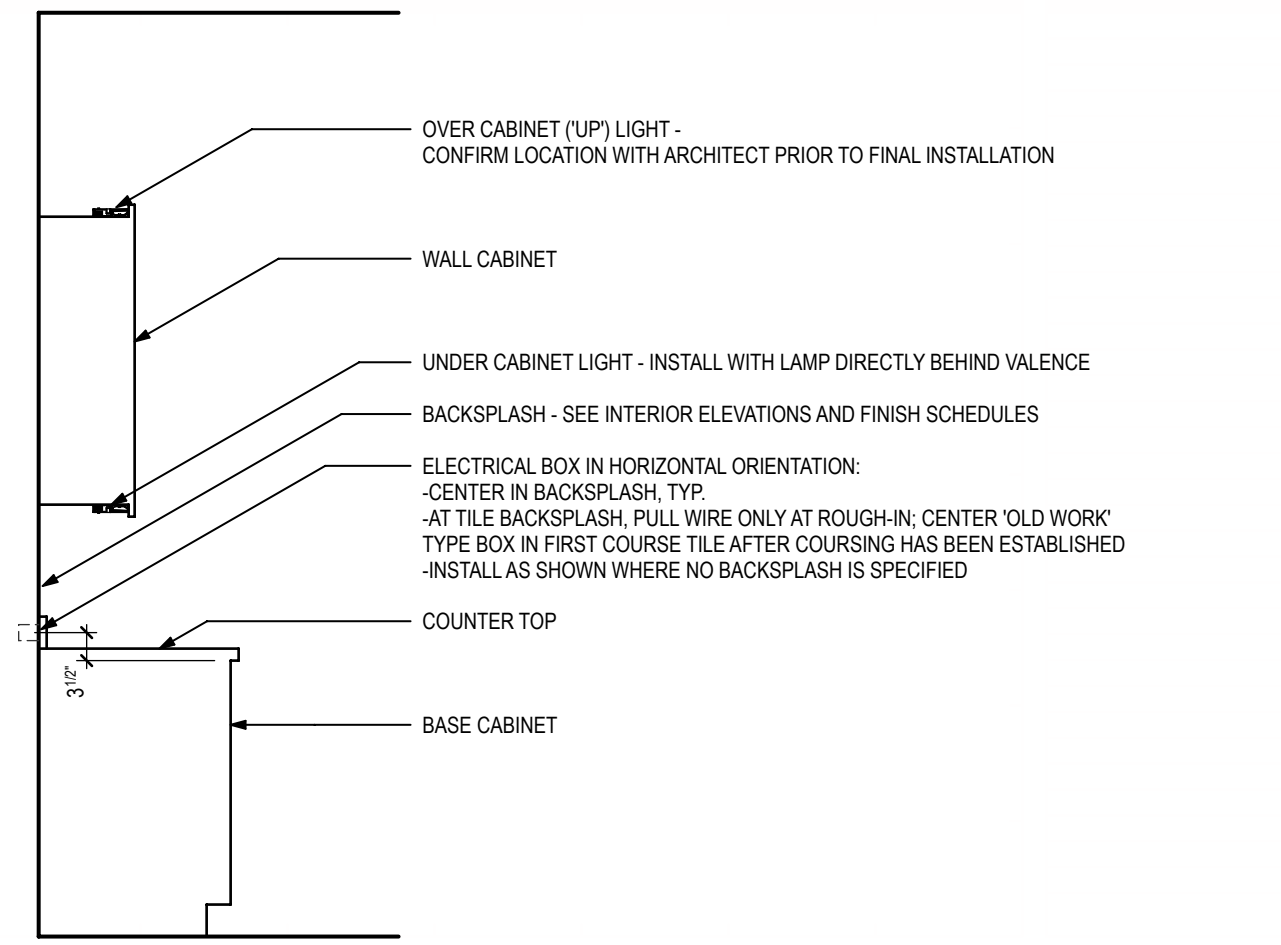

ELECTRICAL DEVICES AT CABINETS & COUNTERS

SCALE: 1/2" = 1'-0"

SAMSEL ARCHITECTS
P.A.
60 Biltmore Avenue
Asheville, NC 28801
P: 828.253.1124
F: 828.254.7316
www.samselarchitects.com

REGISTERED ARCHITECT
NORTH CAROLINA
11501
REGISTERED ARCHITECT
NORTH CAROLINA
51039

PROJECT:
Loftin-Skigen Renovation
14 Stuyvesant Rd
Biltmore Forest, NC 28803

SHEET TITLE:
ELECTRICAL NOTES & LEGEND

DATE:	DESCRIPTION:
02.23.15	BOARD OF ADJUSTMENT
03.13.15	OWNER REVIEW
04.03.15	OWNER REVIEW
04.16.15	OWNER REVIEW
04.24.15	OWNER REVIEW
05.01.15	PERMIT SET

PROJECT #:
14.41
DRAWN BY: **DKT** CHECKED BY: **JS**
SHEET #:

E-100
COPYRIGHT 2014
SAMSEL ARCHITECTS, P.A.

PRELIMINARY - FOR INTENT ONLY
NOT FOR CONSTRUCTION

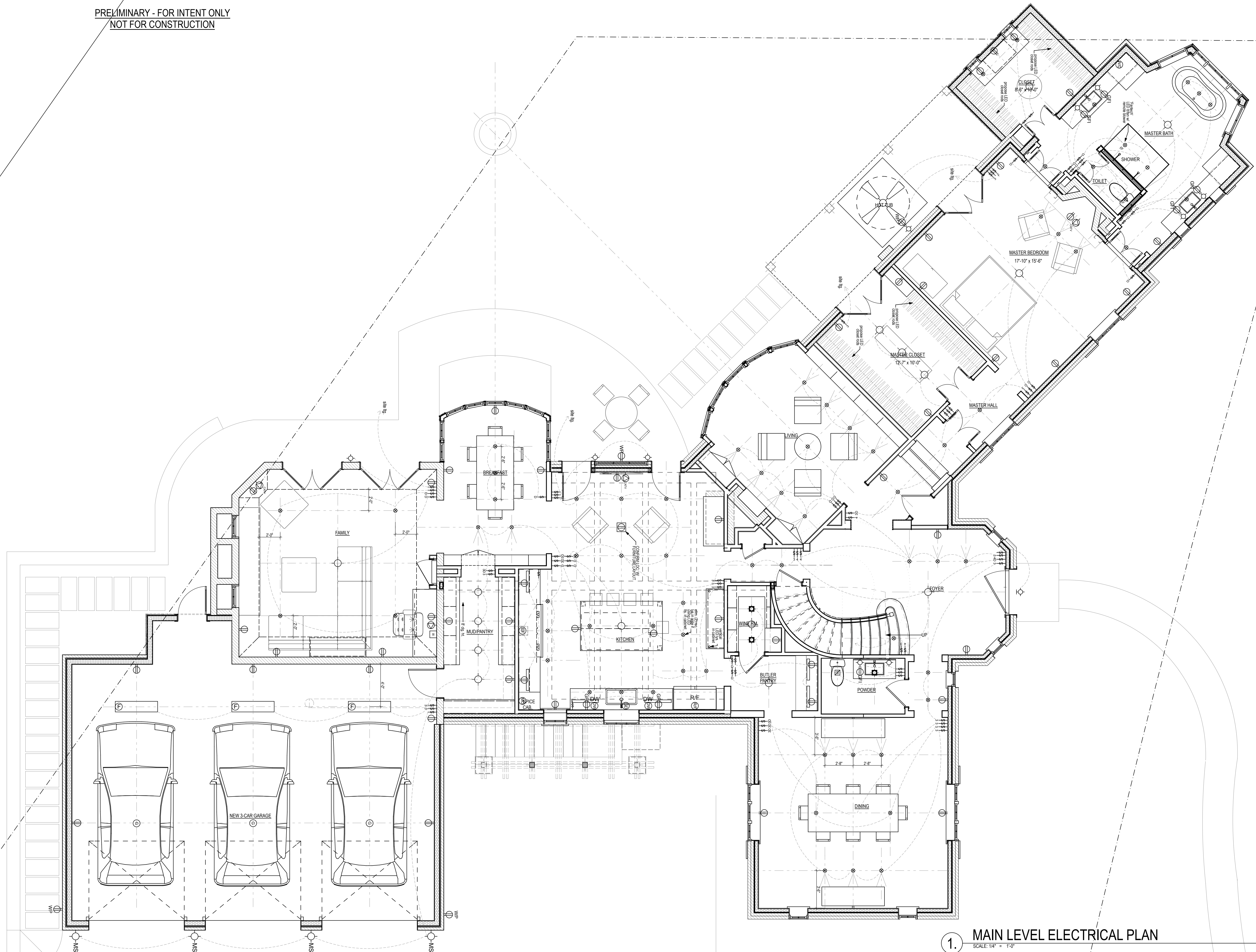

1. MAIN LEVEL ELECTRICAL PLAN
SCALE 1/4" = 1'-0"

SAMSEL ARCHITECTS
P.A.
60 Biltmore Avenue
Asheville, NC 28801
P: 828.253.1124
F: 828.254.7316
www.samselarchitects.com

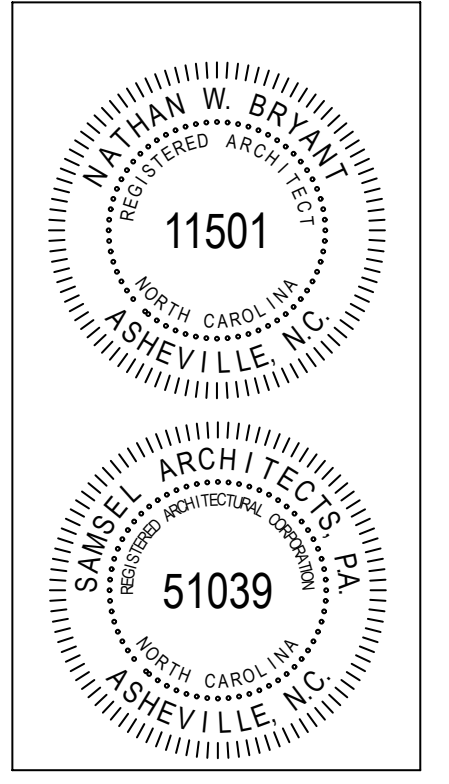

PROJECT:
Loftin-Skigen Renovation

14 Stuyvesant Rd
Biltmore Forest, NC
28803

SHEET TITLE:
MAIN LEVEL ELECTRICAL PLAN

DATE:	DESCRIPTION:
02.23.15	BOARD OF ADJUSTMENT
03.13.15	OWNER REVIEW
04.03.15	OWNER REVIEW
04.16.15	OWNER REVIEW
04.24.15	OWNER REVIEW
05.01.15	PERMIT SET

PROJECT #:
14.41
DRAWN BY: **DKT** CHECKED BY: **JS**
SHEET #:

E-102
COPYRIGHT 2014
SAMSEL ARCHITECTS, P.A.

CREATION DATE: 6/17/15

PRELIMINARY - FOR INTENT ONLY
NOT FOR CONSTRUCTION

SAMSEL ARCHITECTS
P.A.
60 Biltmore Avenue
Asheville, NC 28801
P: 828.253.1124
F: 828.254.7316
www.samselarchitects.com

NATHAN W. BRYAN
REGISTERED ARCHITECT
11501
NORTH CAROLINA
ASHEVILLE, N.C.

SAMSEL ARCHITECTS, P.A.
REGISTERED PROFESSIONAL ARCHITECTS
51039
NORTH CAROLINA
ASHEVILLE, N.C.

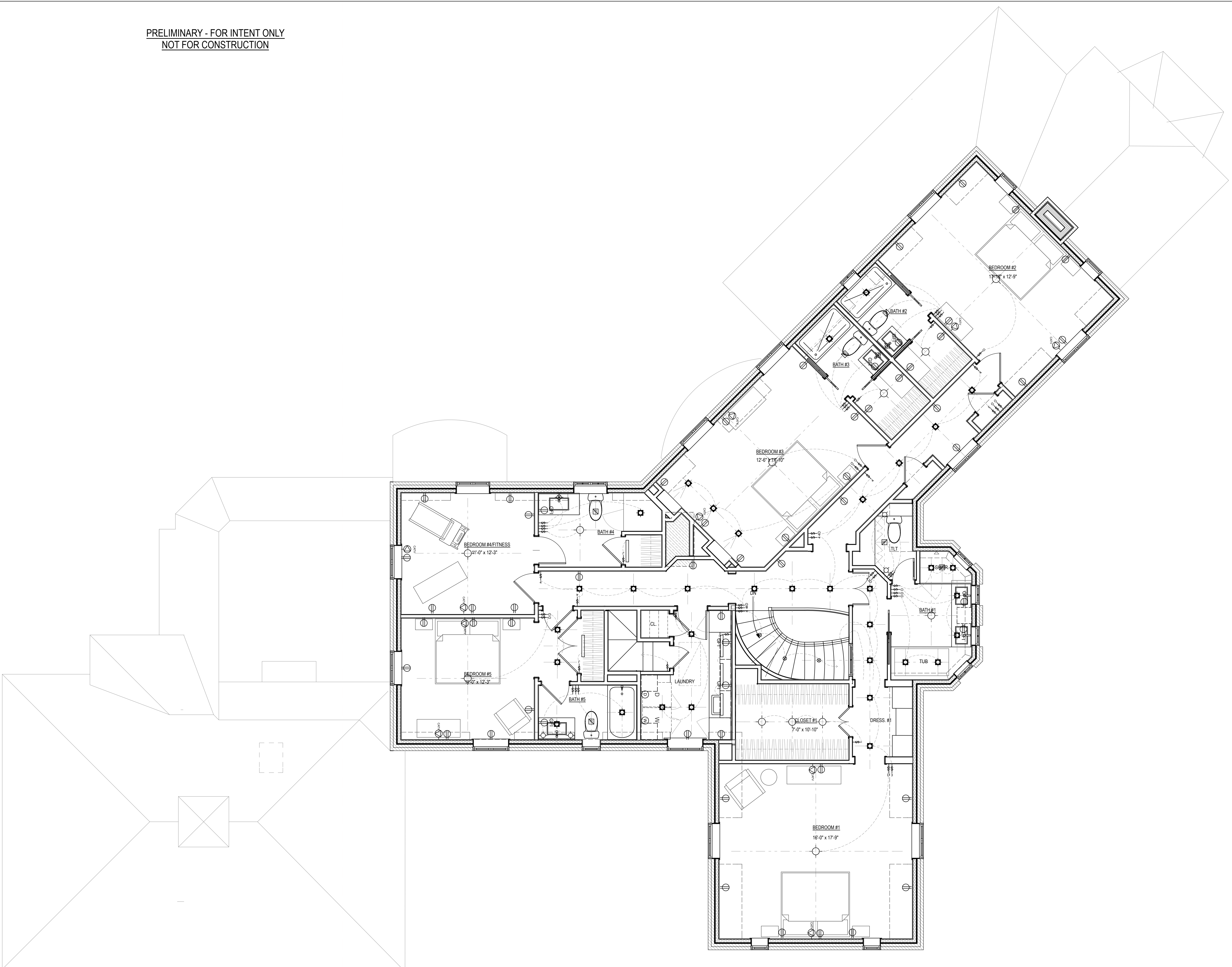

PROJECT:

Loftin-Skigen
Renovation

14 Stuyvesant Rd
Biltmore Forest, NC
28803

SHEET TITLE:

UPPER LEVEL
ELECTRICAL
PLAN

DATE:	DESCRIPTION:
02.23.15	BOARD OF ADJUSTMENT
03.13.15	OWNER REVIEW
04.03.15	OWNER REVIEW
04.16.15	OWNER REVIEW
04.24.15	OWNER REVIEW
05.01.15	PERMIT SET

PROJECT #:

14.41

DRAWN BY:

DKT

CHECKED BY:

JS

SHEET #:

E-103

COPYRIGHT 2014
SAMSEL ARCHITECTS, P.A.

3. UPPER LEVEL ELECTRICAL PLAN
SCALE: 1/4" = 1'-0"

CREATION DATE: 6/17/15

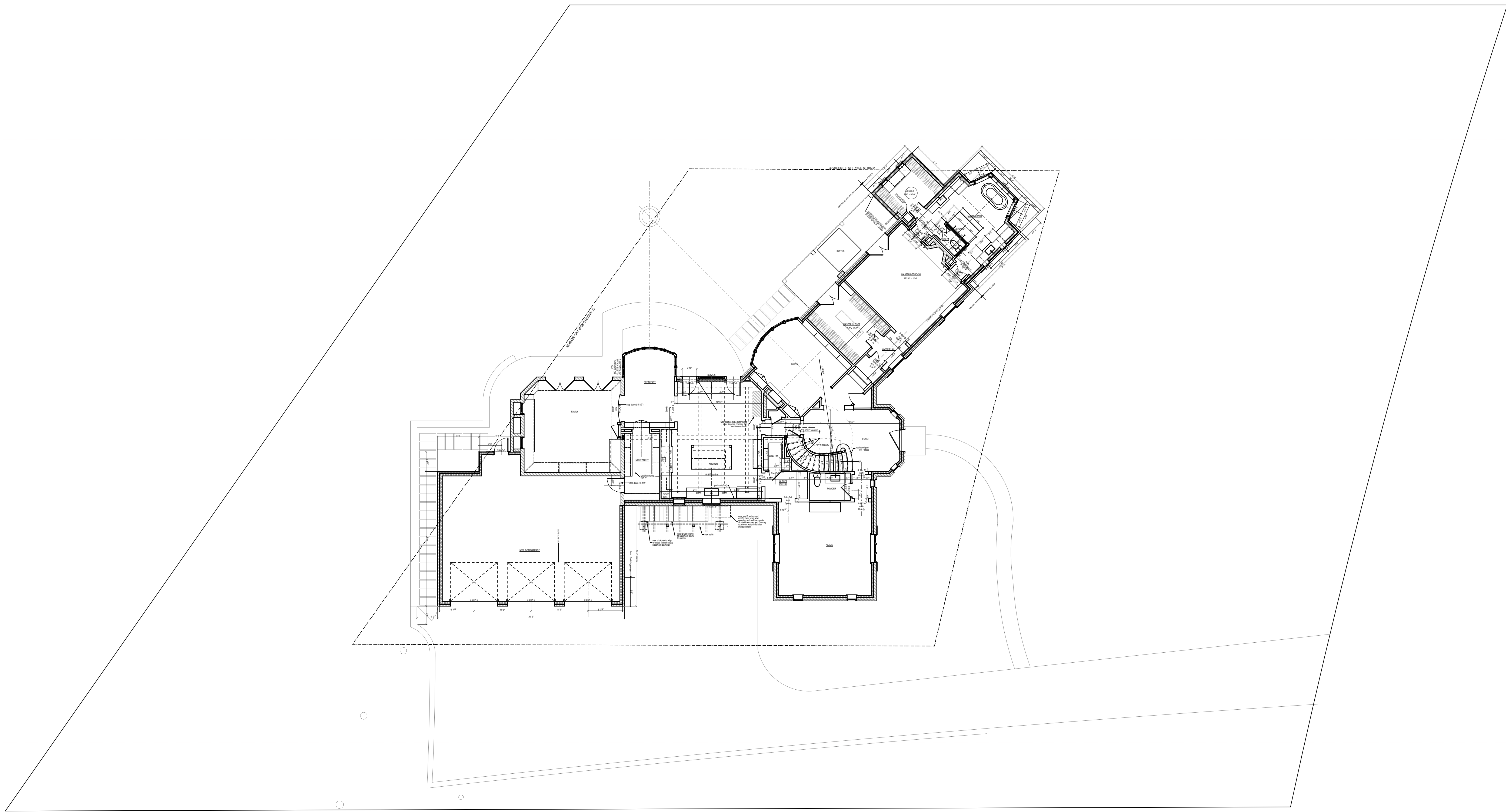

1 SITE PLAN
SCALE: 1" = 10'

SAMSEL ARCHITECTS
P.A.
60 Biltmore Avenue
Asheville, NC 28801
P: 828.253.1124
F: 828.254.7316
www.samselarchitects.com

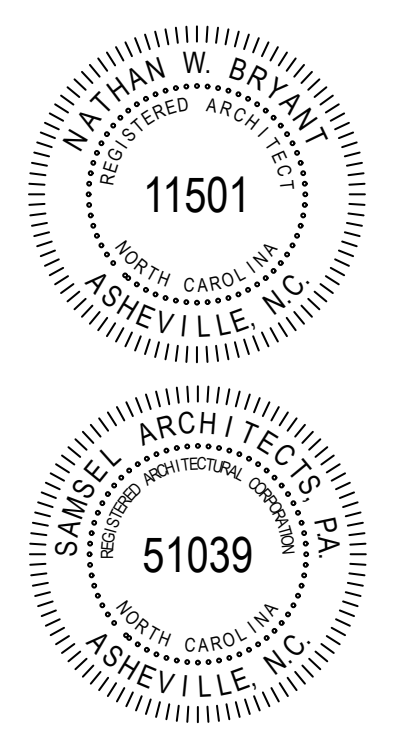

PROJECT:

**Loftin-Skigen
Renovation**

14 Stuyvesant Rd
Biltmore Forest, NC
28803

SHEET TITLE:

SITE PLAN

DATE:	DESCRIPTION:
02.23.15	BOARD OF ADJUSTMENT
03.13.15	OWNER REVIEW
04.03.15	OWNER REVIEW
04.16.15	OWNER REVIEW
04.24.15	OWNER REVIEW
05.01.15	PERMIT SET

PROJECT #:

14.41

DRAWN BY: **DKT** CHECKED BY: **JS**

SHEET #:

L-101

COPYRIGHT 2014
SAMSEL ARCHITECTS, P.A.

4/7

Map 7

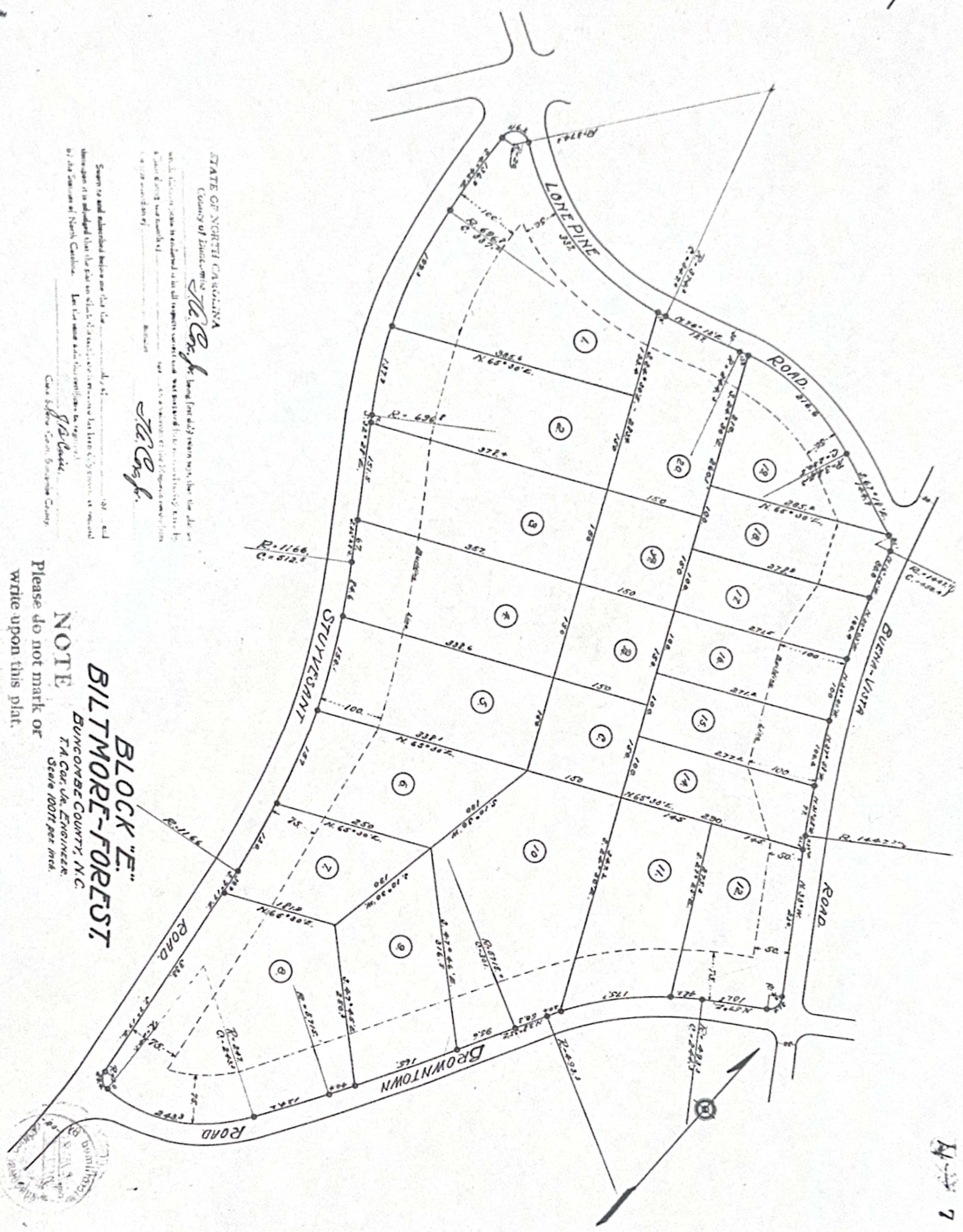

STATE OF NORTH CAROLINA
 County of Buncombe
 J. A. Carver, Jr.
 Surveyor
 J. A. Carver, Jr.
 Surveyor

BLOCK "E"
BILTMORE-FOREST.
 BUNCOMBE COUNTY, N. C.
 J. A. Carver, Jr., ENGINEER.
 Scale 100' = 1" per inch.



NOTE
 Please do not mark or
 write upon this plat.

cc



Doc ID: 027786220003 Type: CPP
Recorded: 12/19/2014 at 04:36:14 PM
Fee Amt: \$2,226.00 Page 1 of 3
Revenue Tax: \$2,200.00
Workflow# 0000249959-0001
Buncombe County, NC
Drew Reinsinger Register of Deeds
BK 5271 PG 831-833

NORTH CAROLINA GENERAL WARRANTY DEED

Excise Tax: \$ 2,200.00

Parcel Identifier No. 964688488100000 Verified by _____ County on the _____ day of _____, 20____
By: _____

Mail/Box to: Goosmann Rose Colvard & Cramer, P.A., 77 Central Avenue, Suite H, Asheville, NC 28801, Box 81

This instrument was prepared by: Goosmann Rose Colvard & Cramer, P.A., (14-3417 GFG cy ks)

Brief description for the Index: _____

THIS DEED made this 19th day of December, 2014 by and between

GRANTOR	GRANTEE
Sandra F. Sellers and Daniel B. Sellers, Married to Each Other 14 Stuyvesant Road Asheville, NC 28803	Jeffrey A. Loftin unmarried 526 Pinchot Drive Asheville, NC 28803

Enter in appropriate block for each Grantor and Grantee: name, mailing address, and if appropriate, character of entity, e.g. corporation or partnership.

The designation Grantor and Grantee as used herein shall include said parties, their heirs, successors, and assigns, and shall include singular, plural, masculine, feminine or neuter as required by context.

WITNESSETH, that the Grantor, for a valuable consideration paid by the Grantee, the receipt of which is hereby acknowledged, has and by these presents does grant, bargain, sell and convey unto the Grantee in fee simple, all that certain lot or parcel of land situated in the City of Asheville, Township, Buncombe County, North Carolina and more particularly described as follows:

See Exhibit "A" attached hereto and incorporated herein by reference.

This instrument was prepared by George F. Goosmann, IV, a licensed NC attorney. Delinquent taxes, if any, to be paid by the closing attorney to the county tax collector upon disbursement of closing proceeds.

The property hereinabove described was acquired by Grantor by instrument recorded in Book 1516 page 411.

All or a portion of the property herein conveyed includes or X does not include the primary residence of a Grantor.

A map showing the above described property is recorded in Plat Book 4 page 7.

NC Bar Association Form No. 3 © 1976. Revised © 1/1/2010
Printed by Agreement with the NC Bar Association

2

TO HAVE AND TO HOLD the aforesaid lot or parcel of land and all privileges and appurtenances thereto belonging to the Grantee in fee simple.

And the Grantor covenants with the Grantee, that Grantor is seized of the premises in fee simple, has the right to convey the same in fee simple, that title is marketable and free and clear of all encumbrances, and that Grantor will warrant and defend the title against the lawful claims of all persons whomsoever, other than the following exceptions: Easements, restrictions, rights of way of record and utility lines readily apparent and in existence over or under the subject property. Ad Valorem taxes for the current year.

IN WITNESS WHEREOF, the Grantor has duly executed the foregoing as of the day and year first above written.

By: _____ (Entity Name) Sandra F. Sellers (SEAL)
Print/Type Name: Sandra F. Sellers

By: _____ (Entity Name) Daniel B. Sellers (SEAL)
Print/Type Name & Title: Daniel B. Sellers

By: _____ (Entity Name) _____ (SEAL)
Print/Type Name & Title: _____ Print/Type Name: _____

By: _____ (Entity Name) _____ (SEAL)
Print/Type Name & Title: _____ Print/Type Name: _____

State of North Carolina - County or City of Buncombe
I, the undersigned Notary Public of the County or City of Buncombe and State aforesaid, certify that Sandra F. Sellers and Husband, Daniel B. Sellers personally appeared before me this day and acknowledged the due execution of the foregoing instrument for the purposes therein expressed. Witness my hand and Notarial stamp or seal this 19th day of December, 2014.

My Commission Expires: 11-1-19
(Affix Seal)



[Signature]
Notary Public
Notary's Printed or Typed Name

State of _____ - County or City of _____
I, the undersigned Notary Public of the County or City of _____ and State aforesaid, certify that _____ personally came before me this day and acknowledged that he is the _____ of _____, a North Carolina or _____ corporation/limited liability company/general partnership/limited partnership (strike through the inapplicable), and that by authority duly given and as the act of such entity, he signed the foregoing instrument in its name on its behalf as its act and deed. Witness my hand and Notarial stamp or seal, this _____ day of _____, 20____.

My Commission Expires: _____
(Affix Seal)

Notary Public
Notary's Printed or Typed Name

State of _____ - County or City of _____
I, the undersigned Notary Public of the County or City of _____ and State aforesaid, certify that _____
Witness my hand and Notarial stamp or seal, this _____ day of _____, 20____.

My Commission Expires: _____
(Affix Seal)

Notary Public
Notary's Printed or Typed Name

Exhibit A

Being all of **Lot 7 of Block E of Biltmore Forest** as shown on a plat thereof as recorded in the Office of the Register of Deeds for Buncombe County, North Carolina in **Plat Book 4 at Page 7**, reference to which is hereby made for a more particular description.

Being the same property described in that deed recorded in Record Book 1516 at Page 411 of the aforesaid Registry.

14-3417



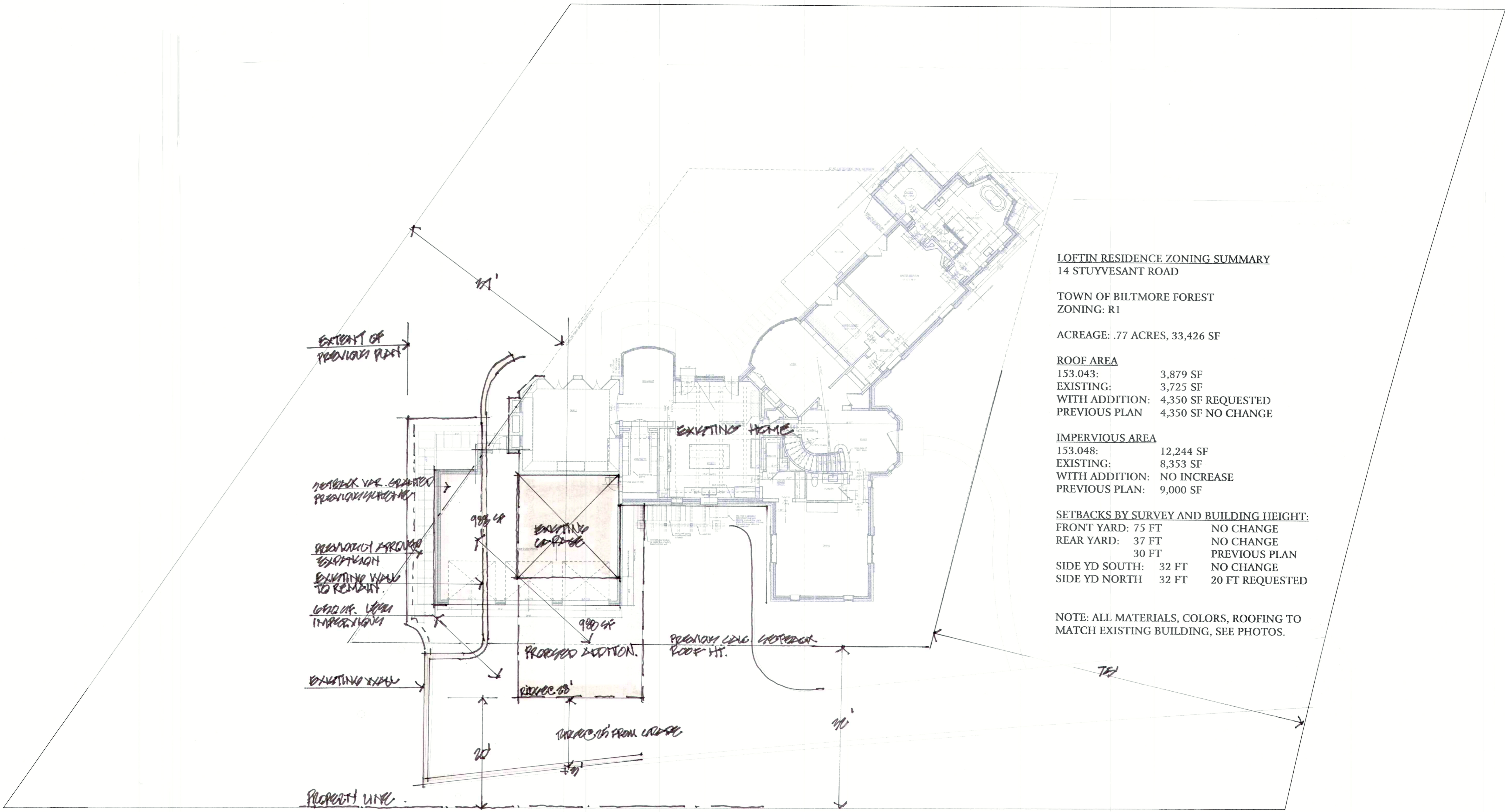

LOFTIN RESIDENCE ZONING SUMMARY
 14 STUYVESANT ROAD

TOWN OF BILTMORE FOREST
 ZONING: R1

ACREAGE: .77 ACRES, 33,426 SF

ROOF AREA
 153.043: 3,879 SF
 EXISTING: 3,725 SF
 WITH ADDITION: 4,350 SF REQUESTED
 PREVIOUS PLAN 4,350 SF NO CHANGE

IMPERVIOUS AREA
 153.048: 12,244 SF
 EXISTING: 8,353 SF
 WITH ADDITION: NO INCREASE
 PREVIOUS PLAN: 9,000 SF

SETBACKS BY SURVEY AND BUILDING HEIGHT:
 FRONT YARD: 75 FT NO CHANGE
 REAR YARD: 37 FT NO CHANGE
 30 FT PREVIOUS PLAN
 SIDE YD SOUTH: 32 FT NO CHANGE
 SIDE YD NORTH 32 FT 20 FT REQUESTED

NOTE: ALL MATERIALS, COLORS, ROOFING TO MATCH EXISTING BUILDING, SEE PHOTOS.

1 SITE PLAN
 SCALE: 1" = 16'

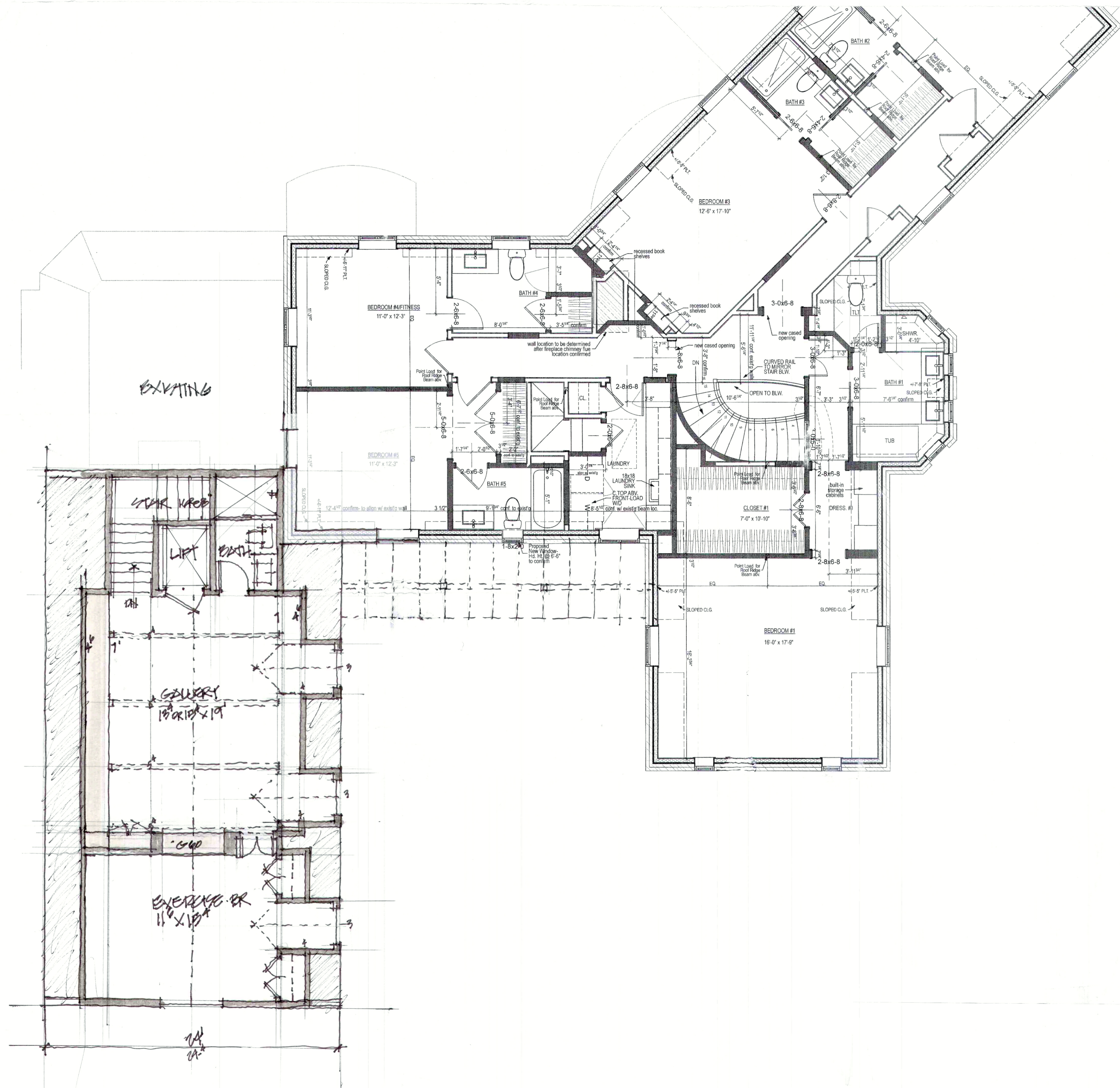

THE ARCHITECTURAL PRACTICE

66 COLLEGE STREET
SUITE 202
ASHEVILLE, NC 28801
828.258.9118

BROUN CONWAY DAMERON, AIA
ARCHITECT

NORTH CAROLINA 4528
SOUTH CAROLINA 6457

American Institute of Architects
National Council of Architectural Registration Boards

HISTORIC ADAPTATION
LONG RANGE PLANNING
OFFICE PLANNING
RESIDENTIAL DESIGN
MOUNTAIN SITES
COMMERCIAL DESIGN
COASTAL ARCHITECTURE
INTERIOR RENOVATIONS

The drawings, specifications and other documents prepared by the Architect for this project are instruments of the Architect's service for use solely with respect to this project. The Architect shall be deemed the author of these documents and shall retain all common law, statutory and other reserved rights, including the copyright. These documents shall not be used in whole or in part for any other project or purposes, or by any other parties from those outpasse by contract, nor used as design documents by other parties to follow with construction documents, without the specific written authorization of the Architectural Practice.

Copyright 2025, The Architectural Practice.

Architect's seal



Firm seal

LOFTIN RESIDENCE

14 STUYVESANT ROAD
BILTMORE FOREST

NORTH CAROLINA

DRAWING REVISIONS:

MARCH 11, 2025

LEVEL TWO PLAN

CONSTRUCTION DRAWINGS

FEBRUARY 25, 2025

SCALE: 1/4"=1'-0"

ARCHITECTURAL DRAWINGS
Sheet Number

A1.2

HISTORIC ADAPTATION
 LONG RANGE PLANNING
 OFFICE PLANNING
 RESIDENTIAL DESIGN
 MOUNTAIN SITES
 COMMERCIAL DESIGN
 COASTAL ARCHITECTURE
 INTERIOR RENOVATIONS

The drawings, specifications and other documents prepared by the Architect for this project are instruments of the Architect's service for use solely with respect to this project. The Architect shall be deemed the author of these documents and shall retain all common law, statutory and other reserved rights, including the copyright. These documents shall not be used in whole or in part for any other project or purposes, or by any other parties than those authorized by contract, nor used as design documents by other parties to follow with construction documents, without the specific written authorization of the Architectural Practice.
 Copyright 2025, The Architectural Practice



PARKING COURT ELEVATION
 1/4"=1'-0"

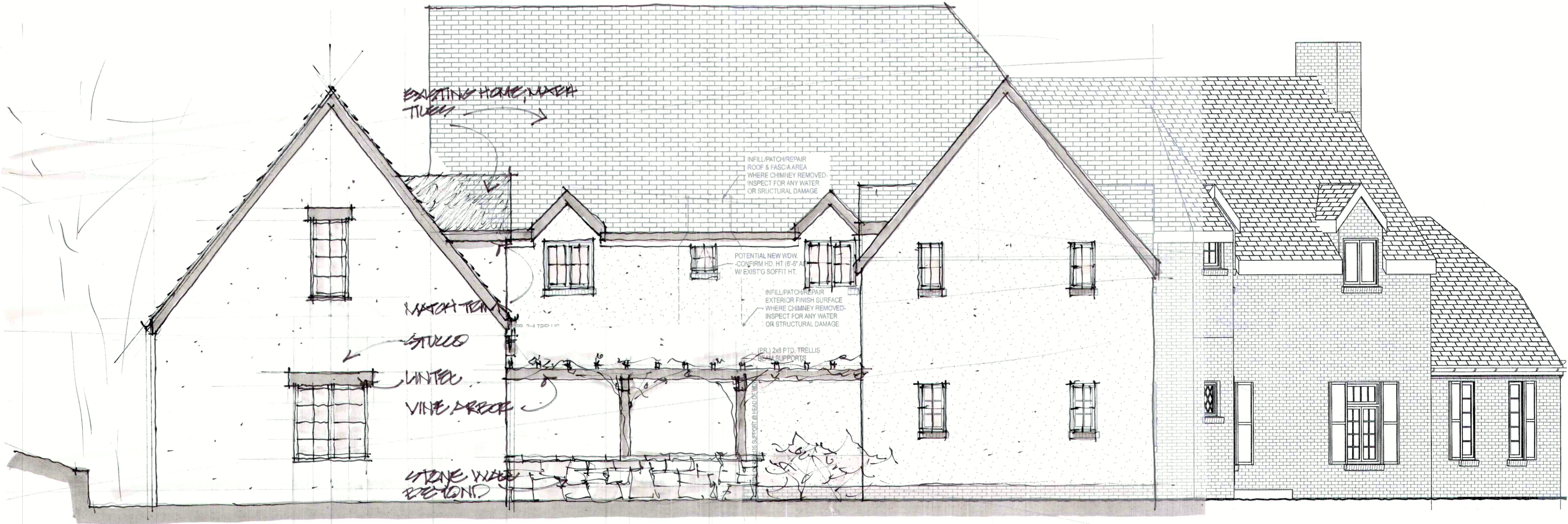

NORTH-PARKING COURT ELEVATION
 1/4"=1'-0"

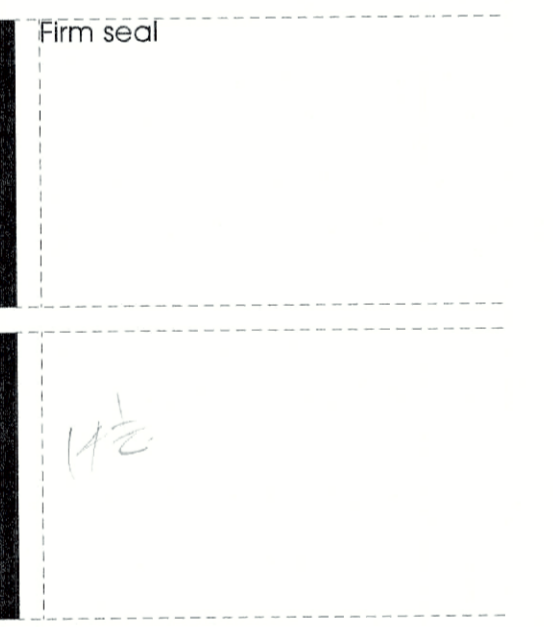

LOFTIN RESIDENCE
 14 STUYVESANT ROAD
 BILTMORE FOREST
 NORTH CAROLINA
 DRAWING REVISIONS:
 MARCH 11, 2025

EXTERIOR ELEVATIONS
 CONSTRUCTION DRAWINGS
 FEBRUARY 25, 2025
 SCALE: 1/4"=1'-0"

ARCHITECTURAL DRAWINGS
 Sheet Number
A2.1

THE ARCHITECTURAL PRACTICE

56 COLLEGE STREET
SUITE 202
ASHEVILLE, NC 28801
828.258.9118

BROUN CONWAY DAMERON, AIA
ARCHITECT

NORTH CAROLINA 4528
SOUTH CAROLINA 6457

American Institute of Architects
National Council of Architectural Registration Boards

HISTORIC ADAPTATION
LONG RANGE PLANNING
OFFICE PLANNING
RESIDENTIAL DESIGN
MOUNTAIN SITES
COMMERCIAL DESIGN
COASTAL ARCHITECTURE
INTERIOR RENOVATIONS

The drawings, specifications and other documents prepared by the Architect for the project are instruments of the Architect's service for use solely with respect to this project. The Architect shall be deemed the author of these documents and shall retain all common law, statutory and other reserved rights, including the copyright. These documents shall not be used in whole or in part for any other project or purposes, or by any other parties from those authorized by contract, nor used as design documents by other parties to follow with construction documents, without the specific written authorization of The Architectural Practice.

Copyright 2025, The Architectural Practice

Architect's seal



Firm seal

LOFTIN RESIDENCE

14 STUYVESANT ROAD
BILTMORE FOREST

NORTH CAROLINA

DRAWING REVISIONS:

MARCH 11, 2025

BUILDING SECTION

SCHEMATIC DESIGN
MARCH 11, 2025
SCALE: 1/4"=1'-0"

ARCHITECTURAL DRAWINGS
Sheet Number

A2.2

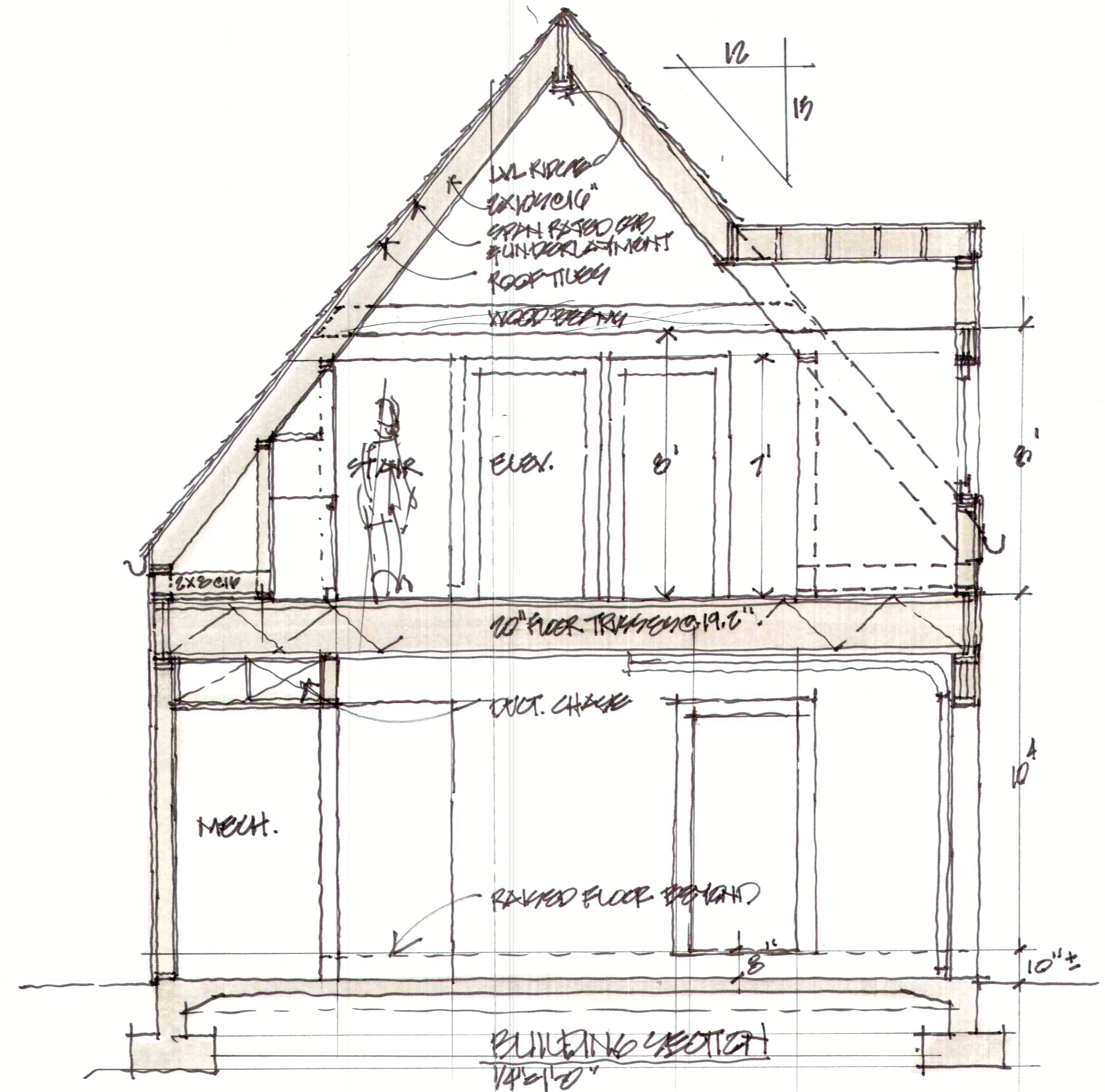

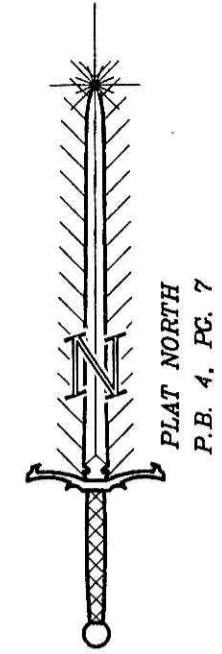

TREE LEGEND

HEM	HEMLOCK
RO	RED OAK
TPL	TRIPLE
WO	WHITE OAK

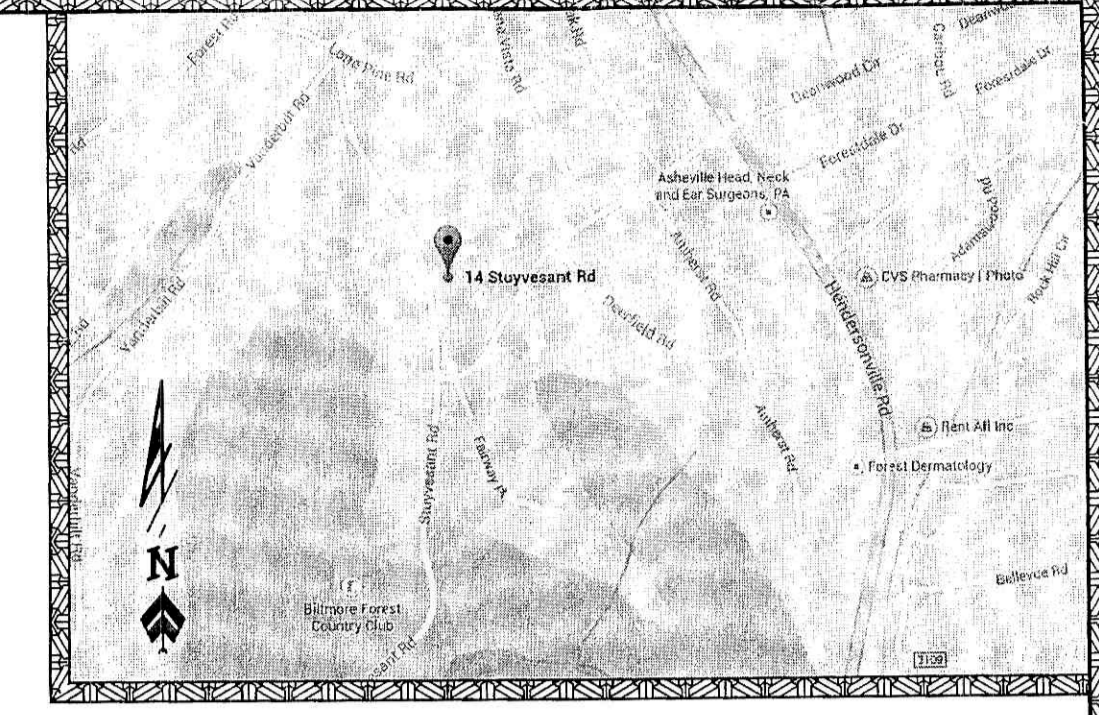

VICINITY MAP NO SCALE

⑩
INGODWE TRUST
D.B. 5162, PG. 396
PIN: 9646-88-7958

⑥
SUZANNE N. DAWKINS
& REBECCA N. LOFTIN, TRUSTEES
D.B. 1980, PG. 434
PIN: 9646-88-4988

⑨
C. C. SWANN
& DOROTHY S. SWANN
D.B. 1100, PG. 643
PIN: 9646-88-6784

⑧
ROBERT P. HARRISON
& LORRAINE O. HARRISON
D.B. 4197, PG. 1008
PIN: 9646-88-5566

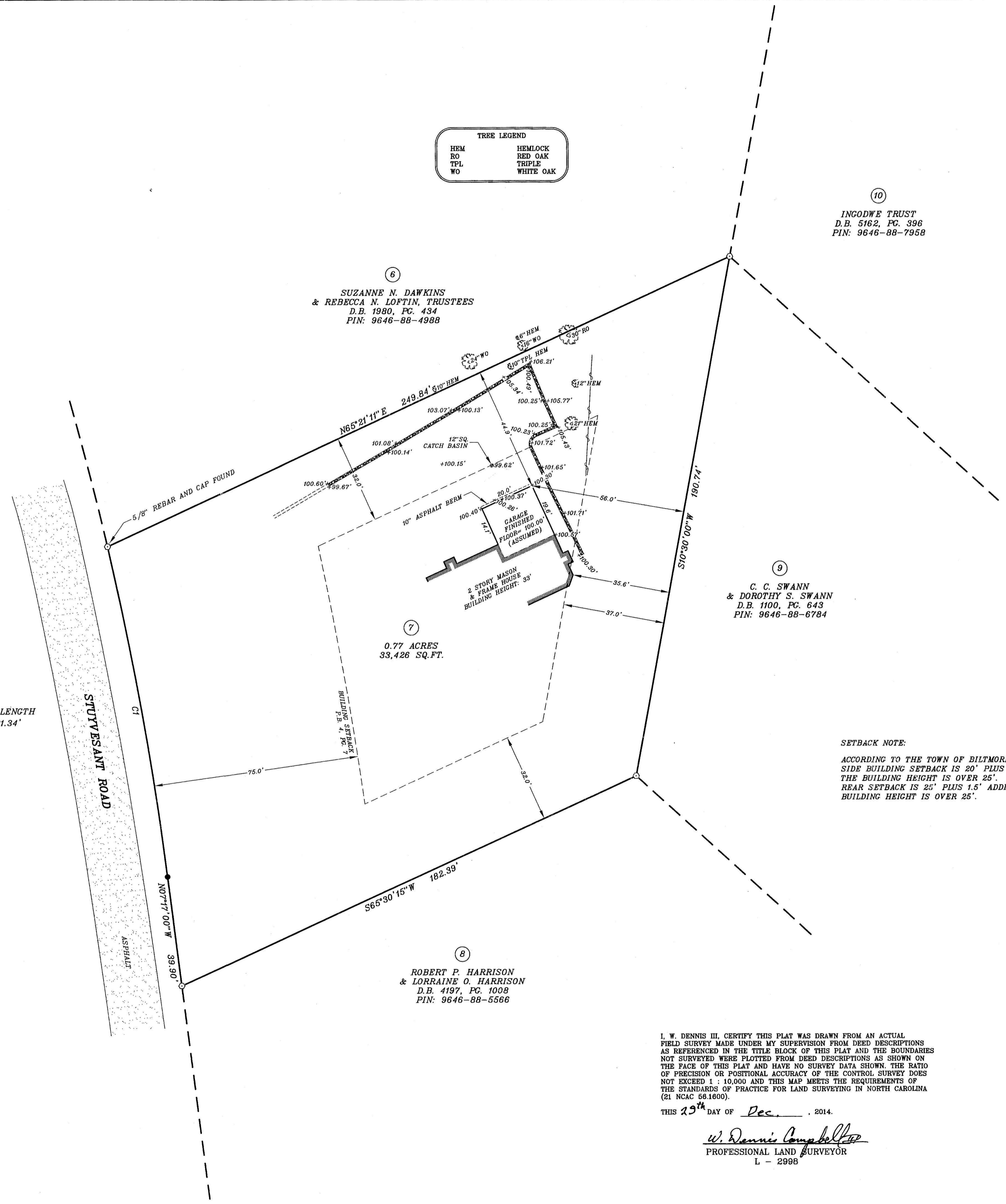

CURVE DATA

CURVE	RADIUS	CHORD DIRECTION	CHORD DISTANCE	ARC LENGTH
C1	1166.00'	N10°06'29\"W	121.29'	121.34'

SETBACK NOTE:
ACCORDING TO THE TOWN OF BILTMORE ZONING ORDINANCE FOR R1,
SIDE BUILDING SETBACK IS 20' PLUS 1.5' ADDITIONAL FOR EVERY FOOT
THE BUILDING HEIGHT IS OVER 25'.
REAR SETBACK IS 25' PLUS 1.5' ADDITIONAL FOR EVERY FOOT THE
BUILDING HEIGHT IS OVER 25'.

- NOTES**
- △ TOTAL AREA = 0.77 ACRES BY COORDINATE METHOD.
 - △ CORNERS AS NOTED ON MAP.
 - △ TOTAL ERROR OF CLOSURE ON THIS SURVEY DOES NOT EXCEED 1:10,000.
 - △ ALL DISTANCES SHOWN ARE HORIZONTAL DISTANCES.
 - △ UNDERGROUND UTILITIES HAVE NOT BEEN LOCATED.
 - △ ONLY THE FEATURES LOCATED ARE SHOWN.
 - △ PROPERTY SHOWN IS SUBJECT TO RESTRICTIONS AND EASEMENTS OF RECORD.
 - △ THERE ARE NO GEODETIC GRID MONUMENTS WITHIN 2,000 OF THE SUBJECT PROPERTY.
 - △ SUBJECT PROPERTY IS NOT LOCATED IN A SPECIAL FLOOD HAZARD AREA, ACCORDING TO FEMA MAP #3700964600J, EFFECTIVE DATE: JAN. 6, 2010.
 - △ SUBJECT PROPERTY IS ZONED BILTMORE FOREST R1 BUILDING SETBACKS:
FRONT: 75'
SIDE: 20' PLUS 1.5' ADDITIONAL FOR EVERY FOOT THE BUILDING HEIGHT IS OVER 25'
REAR: 25' PLUS 1.5' ADDITIONAL FOR EVERY FOOT THE BUILDING HEIGHT IS OVER 25'
 - △ INFORMATION PERTAINING TO PROPERTY OWNERS SHOWN ON THIS MAP IS NOT TO BE CONSTRUED AS A TITLE CERTIFICATION.
- xx INDICATES PLAT LOT NUMBER, P.B. 4, PG. 7

LEGEND

●	POINT NOT SET
○	5/8" REBAR FOUND
○	UNLESS OTHERWISE NOTED
+100.00'	SPOT ELEVATION
—	CHAIN LINK FENCE
—	SURVEYED BOUNDARY
---	BOUNDARY - NOT SURVEYED
---	BUILDING SETBACK
---	STONE RETAINING WALL
○	TREE

I, W. DENNIS III, CERTIFY THIS PLAT WAS DRAWN FROM AN ACTUAL FIELD SURVEY MADE UNDER MY SUPERVISION FROM DEED DESCRIPTIONS AS REFERENCED IN THE TITLE BLOCK OF THIS PLAT AND THE BOUNDARIES NOT SURVEYED WERE PLOTTED FROM DEED DESCRIPTIONS AS SHOWN ON THE FACE OF THIS PLAT AND HAVE NO SURVEY DATA SHOWN. THE RATIO OF PRECISION OR POSITIONAL ACCURACY OF THE CONTROL SURVEY DOES NOT EXCEED 1 : 10,000 AND THIS MAP MEETS THE REQUIREMENTS OF THE STANDARDS OF PRACTICE FOR LAND SURVEYING IN NORTH CAROLINA (21 NCAC 58.1600).

THIS 29th DAY OF Dec., 2014.

W. Dennis Campbell III
PROFESSIONAL LAND SURVEYOR
L - 2998

SURVEY FOR
JEFFREY A. LOFTIN
OF
LOT 7, BLOCK 'E'
BILTMORE FOREST
PIN LOT: 9646-88-4881
BILTMORE FOREST TWP., BUNCOMBE CO., N.C.
REF: D.B. 1516, PG. 411; P.B. 4, PG. 7

20' 0' 20' 40' 60'
SCALE: 1" = 20' DATE: DEC. 24, 2014

BLUE RIDGE LAND SURVEYING, INC.
SERVING WESTERN NORTH CAROLINA
WITH A FULL RANGE OF LAND SURVEYING SERVICES
www.BlueRidgeLandSurvey.com
PHONE: (828) 252-6092
LICENSE C-0463
P.O. BOX 3091 - ASHEVILLE, N.C. - 28802

Buncombe County

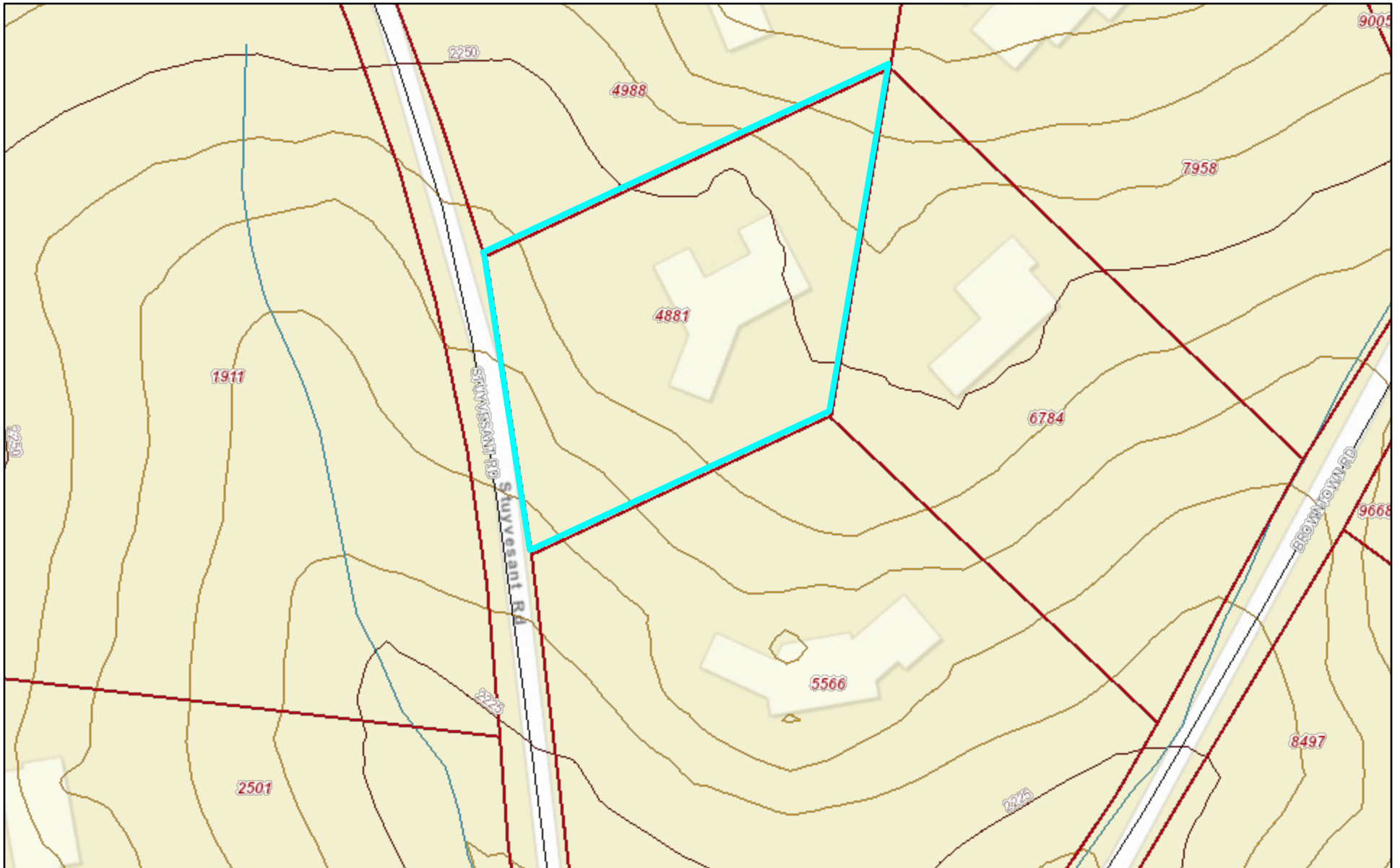

March 27, 2025

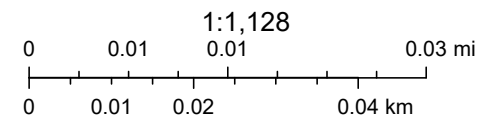

Sources: Esri, HERE, Garmin, USGS, Intermap, INCREMENT P, NRCan, Esri Japan, METI, Esri China (Hong Kong), Esri Korea, Esri (Thailand),











BOARD OF ADJUSTMENT MEETING

STAFF MEMORANDUM

April 21, 2025

CASE 4

Property Address: 49 Forest Rd
Property Owner: Vinton Murray
Request: Hearing for Variance Request for Accessory Structures

Background

The property owner is presenting plans for multiple accessory structures within the front of their home. The structures are to include two retaining walls along the driveway. The first wall will be twenty-inch-high stones at one hundred twenty-five feet long. The second will be stones eight inches in height and twenty-five feet long. Next would be a deer fence within the front yard as part of a flower garden. The fence will be eight feet tall and one hundred thirty linear feet around the perimeter of the garden. Also, within the flower garden there will be a small fountain. Lastly there will be four, six-foot-long curved benches within the garden. The application does not meet the requirements set forth in the ordinance, therefore it would require a variance.

Variance

The proposed walls, benches, fountain and fence do not meet the ordinance requirement to be located within the rear yard and therefore would require a variance. Section 153.110 (D) (attached) addresses the approval requirements for a variance.

Zoning Compliance Application

Town of Biltmore Forest

Name

Vinton Murray

Property Address

49 Forest Road

Phone

(828) 277-5489

Email

vinton.murray@me.com

Parcel ID/PIN Number

9646-69-9904

ZONING INFORMATION

Current Zoning

R-1

Lot Size

1.86

Proposed Roof Coverage Total

None

Proposed Impervious Surface Coverage

replacement of existing steps, paths and driveway

Front Yard Setback

60 feet (R-1 District)

Side Yard Setback

20 feet (R-1 District)

Rear Yard Setback

25 feet (R-1 District)

Building Height

NA

Description of the Proposed Project

49 Forest Road
Project Description
March 19, 2025

The project that I am undertaking, with the help of professional Garden Designer Nancy Duffy, is primarily to reforest and beautify my property that was destroyed when Hurricane Helene struck WNC on the night of Sept 26, 2024. It hit 49 Forest's lower front yard with a vengeance, and proceeded to damage the upper part of the property, but without the same ferocity that it had displayed below the driveway. Losing the "forest" below my house, (approx. sixty trees) changed many things, some of which have been wonderful. I now have a house full of sunshine and views of our glorious mountains from every window on the front of my house. The goal of this project is to create a beautifully landscaped garden to compliment my much-loved home, designed by architect Henry Gaines in 1957.

The reforesting of the land below my driveway will involve native, non-invasive large deciduous trees, three varieties of evergreen, plus magnolias, dogwood and a variety of shrubs and groundcover. Complimenting the reforesting will be two gardens: a Flower-filled Sun Garden in the lower yard, and an Herb Garden on the upper level. The property that circles the house will be getting a "facelift," with lots of new plantings to compliment some of the existing plants and bring this part of the property to the new level

of beauty that the lower yard will have achieved.

The hardscapes that are involved will be new steps from the upper yard to the driveway and then from the driveway to the lower yard with paths also leading to the Sun Garden, which have a visually attractive deer fence safeguarding my favorite flowers from being nibbled away. The path from the parking area to the front door will be replaced, and as will the driveway, partially protected by a low stone border on the steep slope side of the drive.

I am thrilled to be able to create a new landscape on my property. I love Biltmore Forest; I grew up down the street from #49, and look forward to bringing a piece of Forest Road back to the beauty we all expect in our town.

Estimated Start Date

6/1/2025

Estimated Completion Date

12/31/2026

Estimated Cost of Project

\$150,000.00

Supporting Documentation (Site Plan, Drawings, Other Information)

Murray Prelim Presentation 2-13-25.pdf

Murray Prelim Presentation 2-13-25.pdf

Applicant Signature

Date

3/19/2025

A handwritten signature in black ink, appearing to read "William Murray". The signature is written in a cursive, somewhat stylized font. The first name "William" is on the top line, and "Murray" is on the bottom line. There is a small dot to the left of the signature.

VARIANCE APPLICATION

Town of Biltmore Forest

Name

Vinton Murray

Address

49 Forest Road

Phone

(828) 277-5489

Email

vinton.murray@me.com

Current Zoning/Use

residential

Requested Use

na

APPLICATION REQUIREMENTS: An application to the Board of Adjustment for a variance must be submitted to the Town of Biltmore Forest Town Manager at least 21 days prior to the meeting at which the application will be considered. A pre-application meeting with Town staff is required prior to application submittal to the Board of Adjustment.

What would you like to do with your property?

Reforest and improve the property at 49 Forest Road. I want to create a garden that is attractive and in line with the overall design of Biltmore Forest. Hurricane Helene decimated the lower forest of the property and did a lot of damage to the property above the driveway as well. Please see memo of 4 8 2025 to Tony Williams for details.

What does the ordinance require?

Setbacks of 60ft on the front and 20ft on both sides. We are in compliance.

BOARD OF ADJUSTMENT: N.C.G.S. 160A-388(D) requires that the Board of Adjustment shall vary the provisions of the Zoning Ordinance only upon a showing of ALL the items below. The Board of Adjustment must follow strict procedure and all determinations must be decided by a concurring vote of four-fifths of the members of the Board. It is important to provide detailed supporting documentation for the Board of Adjustment to review. If necessary, additional sheets may be attached to this application.

REQUIRED FINDINGS: Please provide a thorough response to each.

Unnecessary hardship would result from the strict application of the ordinance.

I need to plant my flowers and herbs on the front of the house because. my back yard above the rock wall is extremely steep and essentially. unuseable. Prior to hurricane Helene, I had virtually no sunshine in the house, and now I have wonderful sunshine everywhere on the front of the house..

The hardship results from conditions that are peculiar to the property, such as location, size, or topography.

The house backs up to the Biltmore Estate and the lot was designed in keeping with the design of Forest Road and other lots. The lots are not rectangular but trapezoids front the Biltmore Co. fence at the top of the lot to Forest Road below.

The hardship did not result from actions taken by the applicant or the property owner.

No. Mother Nature hit the property Sept 26 & 27, 2025 and gave me a completely new piece of property., which I see as an opportunity to enhance and improve for my enjoyment, as well as my neighbors,

The requested variance is consistent with the spirit, purpose, and intent of the ordinance, such that public safety is secured, and substantial justice is achieved.

I am not sure about justice or public safety, but I am sure reforesting my lot, and adding beautiful trees, bushes, shrubs and flowers will aid in the overall restoration of our beautiful mountains.

I hereby certify that all of the information set forth above is true and accurate to the best of my knowledge.

Signature

Date

4/7/2025

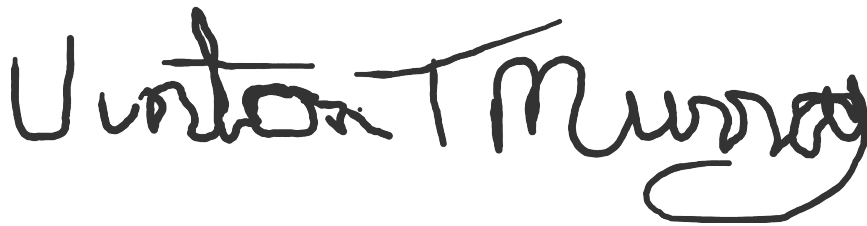
A handwritten signature in black ink that reads "Winston Murray". The signature is written in a cursive style with a large, sweeping loop at the end of the name.

Have you paid the \$300 variance application fee? Your permit application will not be reviewed until payment has been received. You can visit the link below to pay. Copy & paste the link in your browser.

I plan to pay in person or mail a check

Memo

TO: Tony Williams, Biltmore Forest Town Planner

From: Vinton Murray, owner, 49 Forest Road, Biltmore Forest

RE: Answers to Tony Williams' email of 3/27/2025

Date: April 8, 2025

1. Location of easements and utilities on site:

Utilities

There are two pipes from the house to the meters on the street: water and sewer.

The water line was replaced at the end of 2024.

The sewer line was repaired in March of 2025.

I can eyeball the location of the lines; if they need to be marked with flags or paint, I can ask PlumbSmart to do it. They worked on both lines.

Cable and Electricity lines are located at the very back of the property above ground next to the access road beside the Biltmore Company fence/ property line, outside the proposed garden plan.

There is a new invisible fence surrounding the property marked by white flags.

Easement

There is an easement from the Biltmore Co. for an unused and replaced water pipe laid for the estate many years ago, possibly before the Town of Biltmore Forest was created. Tim Rosebrock, an executive with the Biltmore Company, has written that he hopes to approve the plan, and we are planning to meet so that he has a full understanding of the project vis a vis the water pipe. *(FYI, I have maps to show location of the pipe which runs from a corner of the driveway rock wall by the parking pad under the driveway, across the front of the house, under the front porch off the front door and into the woods. I am planning to scan the map and send to you, probably seperately)* Trees, bushes and grass are in the ground over the pipe, and the proposed plan will only do more of the same.

2. Setbacks

As requested Nancy Duffy has added the easement lines (in red) to the architectural plans. The two pdf's showing this are attached. We are not doing any building on the setbacks, just planting on or near setbacks, 60ft from street, and 20ft on either side of property.

3. The Retaining Walls

As one drives up the driveway, the two retaining walls are on the right side of the driveway, beginning with the first curve, to the left, that wall is made of 20" high stones. It travels 125 linear feet to the second curve, continues toward the walkway to the front door. Those stones are 8" high and are 25 linear feet in length.

4. Information on the Sun/ Color Garden's fence and benches

The ornamental deer fence will be stained pressure treated wood (color to be determined). Sections will be 8ft high by 8ft wide, possibly modified, but style to remain the same. There will be two single gates into the garden. The fence will run the circumference of the sun garden, which is 130 linear feet around the 1,000 square foot garden.

The benches will be 6'feet long curved benches. If you want to see the benches, click on

<https://www.countrycasualteak.com/teak-garden-bench-windermere-curved-4508>

5. Impervious surface:

House roof :	3,098 sq ft
Carport & walkway roof:	899 sq. ft
New Driveway	4,785 sq.ft
<u>Total</u>	<u>8,782 sq ft.</u>

The new driveway be restored to the originally designed 12 ft, with a 2ft widening at the two curves to allow for bigger trucks than in 1957 plans for the original house.

Note: For the project itself, the only other possible “impervious surfaces” are the stone steps into the garden, which are replacements for the current steps and walkways into the lower front yard, and a replacement walkway from driveway to the front porch.

6. The variance application will follow, or I may be able to attach it.

Tony, please contact me if you need anything else. Vinton Murray

Murry Residence

Preliminary Landscape Plan

Muddy Boots, Inc.
February 14, 2025

New Features:

- Re-foresting the property with native trees and shrubs
- New path wide enough for a golf cart running across the slope for gradual ascent
- Destination garden just below the drive
- Stone driveway wall on one side
- Stone steps will be comfortable and safe
- New front walk and plantings, including an herb garden
- Gravel courtyard behind house and new perennial plantings in existing wall planter

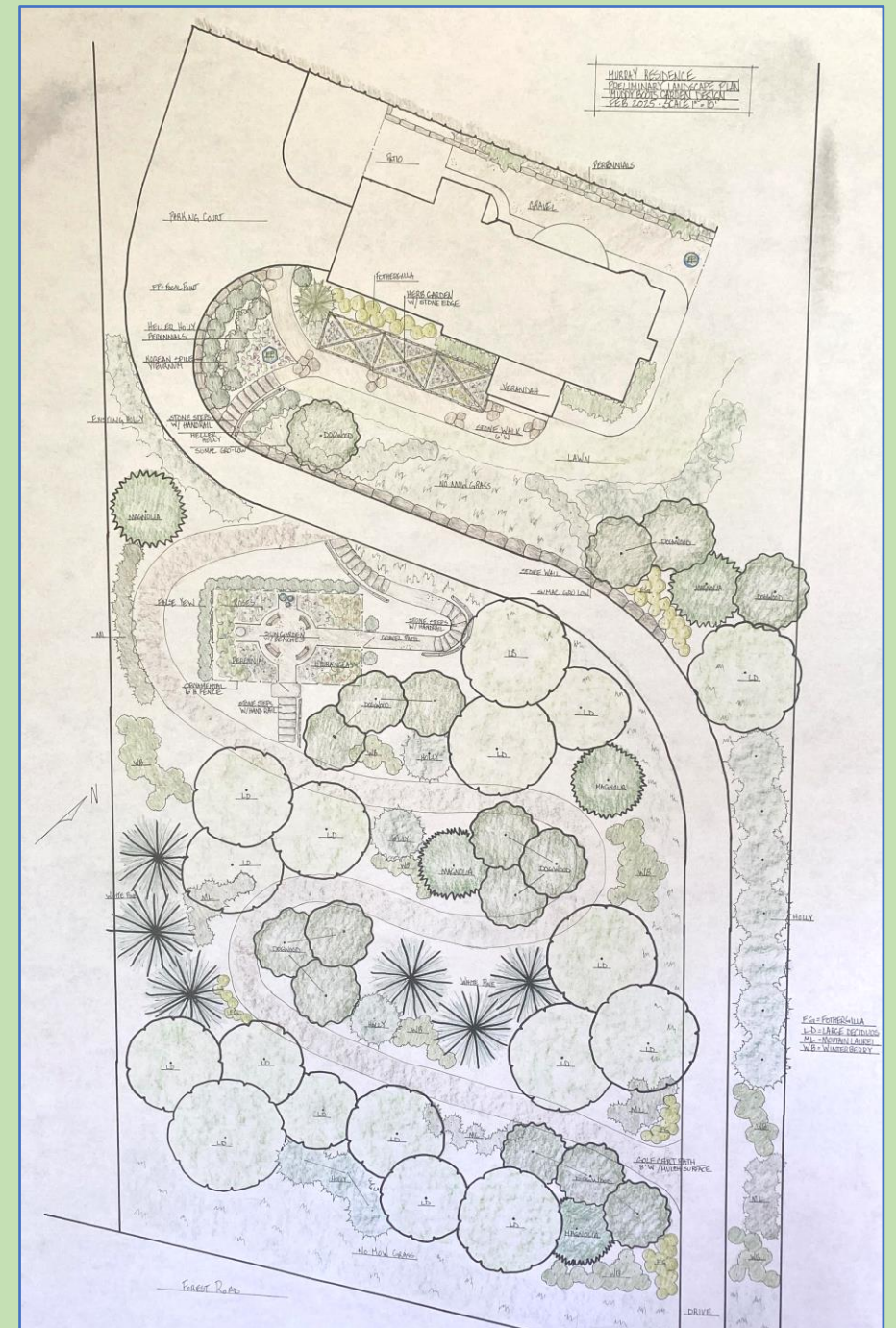

Large Deciduous Trees



Red & White Oak



Red Maple

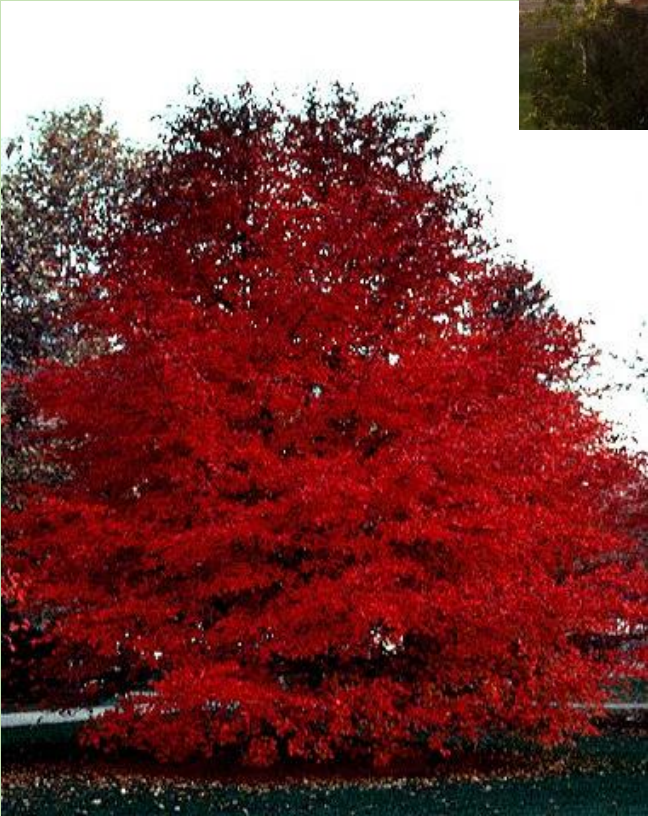

Black Gum



Hickory

Evergreen Trees



Holly 'Oaklands'



White Pine



Magnolia 'Little Gem'

Understory Tree



Dogwood

Shrub Layer

Mountain Laurel



Fothergilla



Winterberry

Covering the Ground

Patches of native groundcover & splashes of spring bulbs



No Mow Grass



Woodland Aster



Pine straw under trees



Bigroot Geranium



Destination Garden

- 6' Ornamental Fence
- Gravel Paths
- Seating
- Fountain
- Colorful pots
- Flowering shrubs and perennials

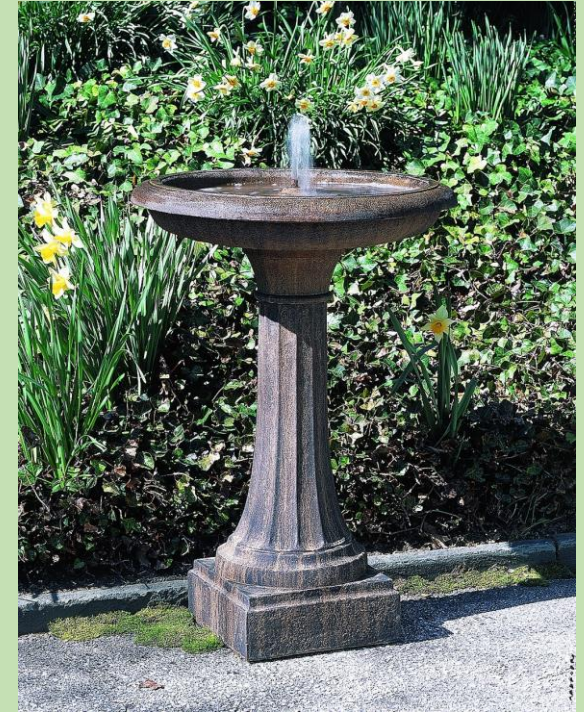

Stonework



- Front walk to be Crab Orchard, grey and tan mixed
- Walk to be 6' wide, mortared
- Walls to be TN Fieldstone, rustic as seen above
- Herb Garden edging to be Crab Orchard edging stone

Stonework

- Steps to be comfortable and safe
- Stone will be Crab Orchard, 5" riser, tread tbd by grade
- Handrail will be metal, simple post and rail



Entrance Garden Plants

Flowering
Perennials



WilsonBros



Heller Holly



Korean Spice Viburnum

Narrow Spruce

Herb Garden



Gravel Courtyard w/ new perennials



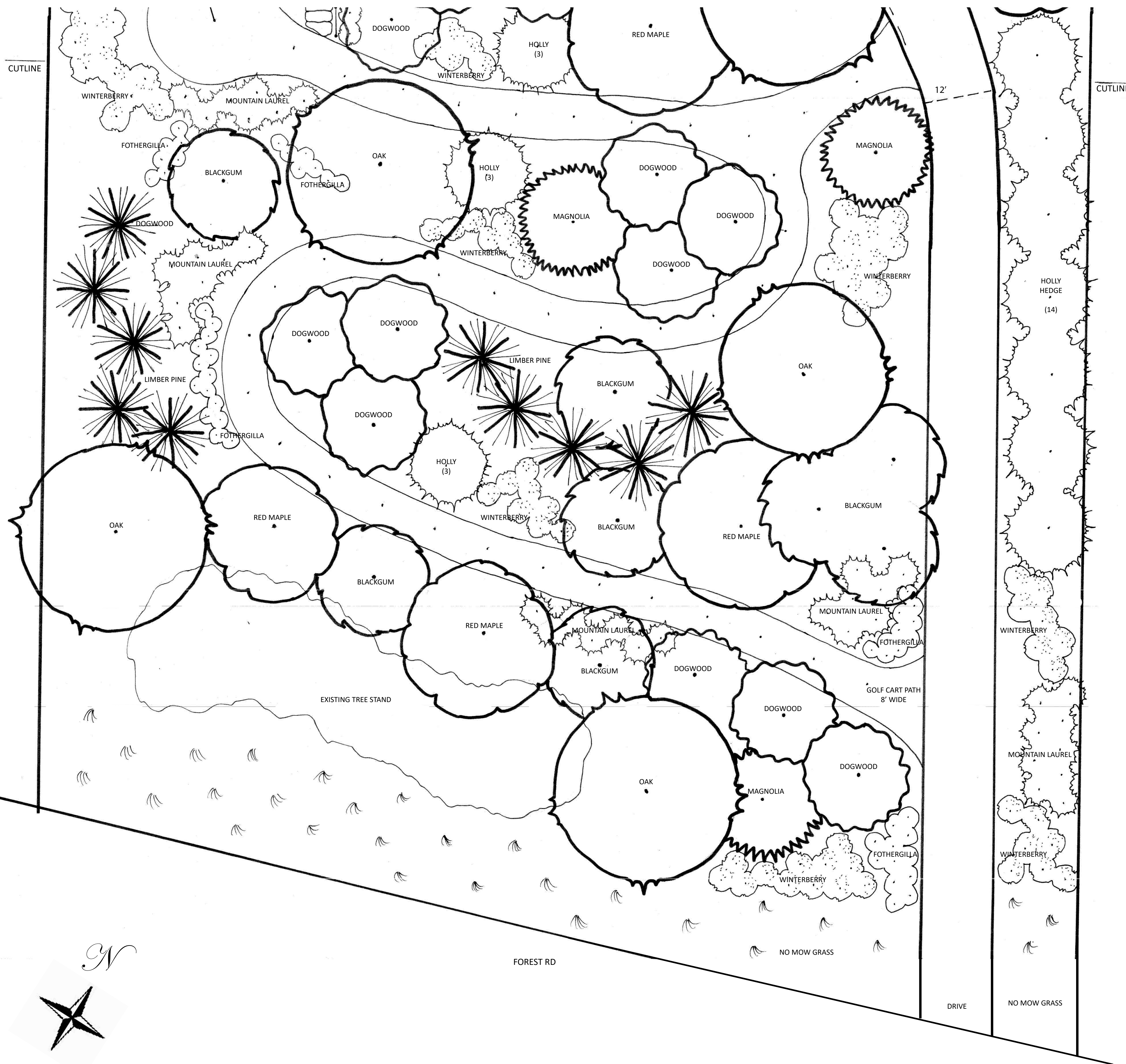

PLANT LIST				
Woodland Garden Notes	Common Name	Botanical Name	Quantity	Installed Size
Conifer	Limber Pine	Pinus flexilis 'Vanderwolf's Pyramid'	15	8' - 10' h
Shrub	Fothergilla	Fothergilla x intermedia 'Mt. Airy'	64	3 gal
Shrub - evergreen	Holly	Ilex 'Christmas Jewel'	20	8" - 9" h
Shrub - evergreen	Mountain Laurel	Kalmia latifolia	42	3 gal
Shrub - fruiting	Winterberry - Female	Ilex verticillata 'Winter Red'	60	3 gal
Shrub - pollinator	Winterberry - Male	Ilex verticillata 'Southern Gentleman'	10	3 gal
Tree - evergreen	Magnolia	Magnolia grandiflora 'Little Gem'	4	6' - 8'
Tree - Large Deciduous	Blackgum	Nyssa sylvatica	11	as large as
Tree - Large Deciduous	Oak	Quercus alba and/or rubra	5	30" basket
Tree - Large Deciduous	Red Maple	Acer rubrum 'October Glory'	4	30" basket
To be sited near larger maples	Red Maple	Acer rubrum 'October Glory'	8	15 gal
Tree - Understory	Dogwood	Cornus florida 'Cherokee Princess'	16	8" - 10"
Total			259	

NOTES PAGE 2 / FULL NOTES PAGE 3

Installation Notes: Golf Cart Path

Layout: Designer will approve the layout (shown on plan)

Layout: The cart turn around near the Color Garden will have a minimum 11' turning radius.

Grading: The path should be 3% or less grade side to side. The junctions with the driveway should be graded for an easy transition.

Drainage: French drains should be installed in any area of drainage concern.

Path surface: The surface of the path will be double ground hard wood.

Installation Notes: Woodland

Plant Removal: Homeowner will have flagged trees removed prior to work commencement.

Plant Removal: The area at the top of the woodland where the drive wall begins will be cleared of debris and the Magnolia pruned.

Existing Plant Material: Woody plant layout will work around existing trees and shrubs.

Layout: The path will be laid out first, then trees and large evergreens will be planted, and finally the shrubs will be planted.

Layout: Designer to work with Installer on layout.

Planting: Planting of all woody material will be done in late fall to minimize watering requirements.

Planting: Woody plants will be pocket planted with 25% amendment added to backfill.

Grass Seed: The slope between the street and the Woodland Garden will be seeded to No Mow Grass. Other areas along the driveway verges will be seeded. TBD

Watering: Installer will water in all new material and work with Homeowner / Designer to plan for watering during establishment.

Mulch: Mulch will be Pine Straw.

NOTE: Future herbaceous and bulb plantings will be considered after woody plant establishment.

DRAWING BASED ON SURVEY AND HOUSE DRAWINGS
 PROVIDED BY HOMEOWNER
 * NOT FOR CONSTRUCTION *

Scale: 1' 0" = 10'
 Date: March 12, 2025
 Page: 2 of 3

MURRAY RESIDENCE
 45 Forest Rd. Biltmore Forest. NC 28803
 Final Landscape Plan

3 Chestnut Mountain Ridge
 Asheville, NC 28803
 828.628.4922



COLOR GARDEN DETAIL

SCALE 1/2" = 10'

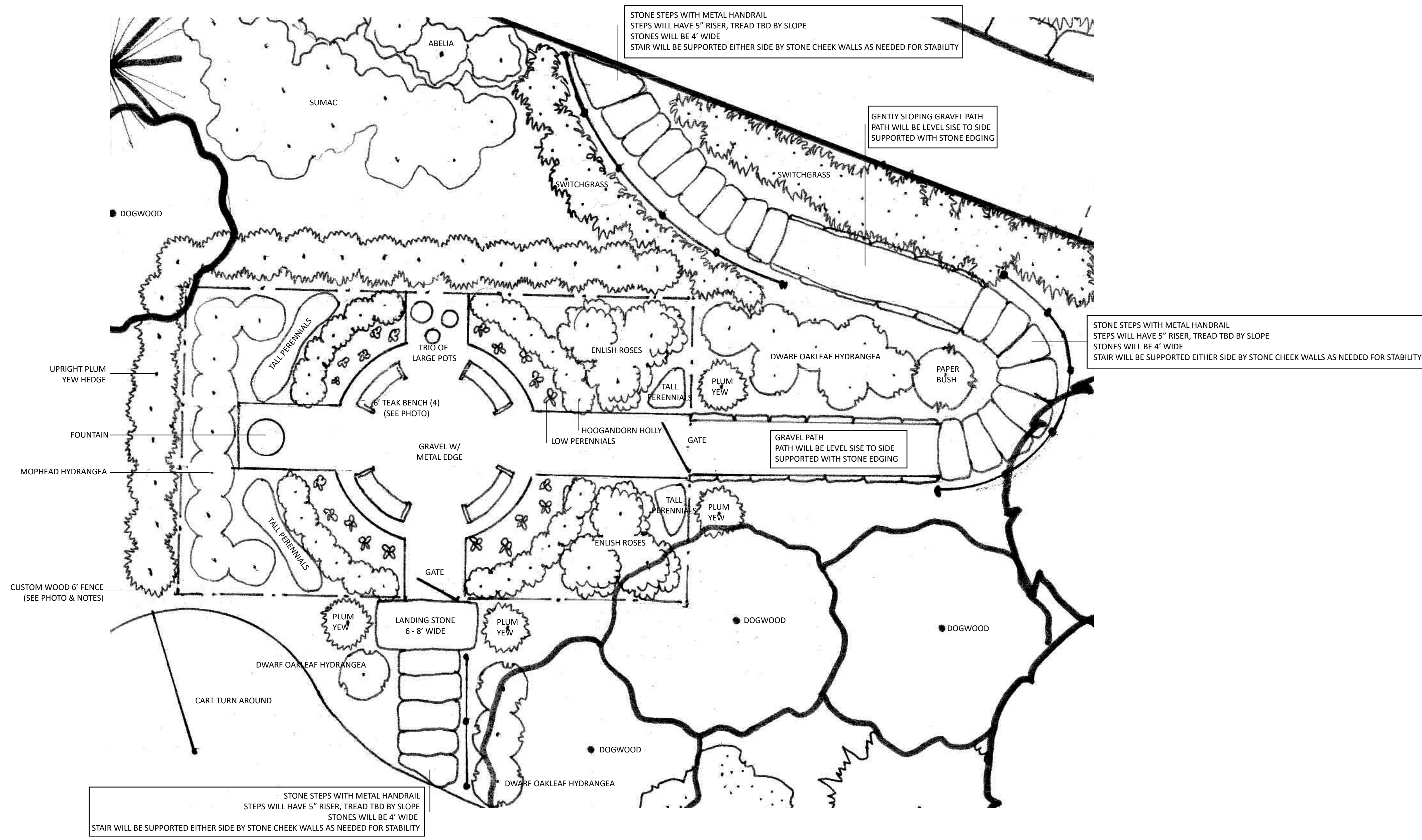

6' CURVED TEAK BENCH FROM COUNTRY CASUAL

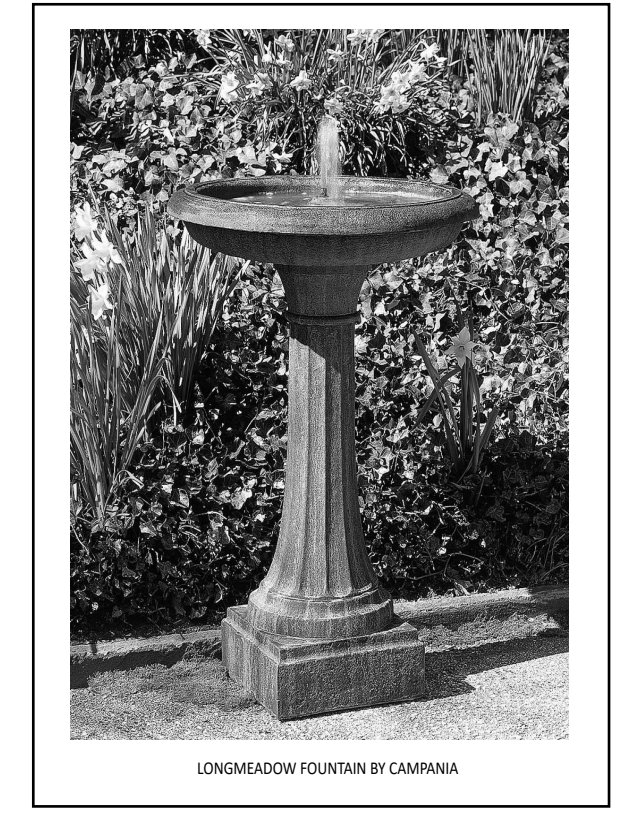

LONGMEADOW FOUNTAIN BY CAMPANIA



HANDRAIL WILL CURVE WITH STEPS BLACK METAL POSTS, NO PICKETS LONG LAMBS TONGUE ENDS

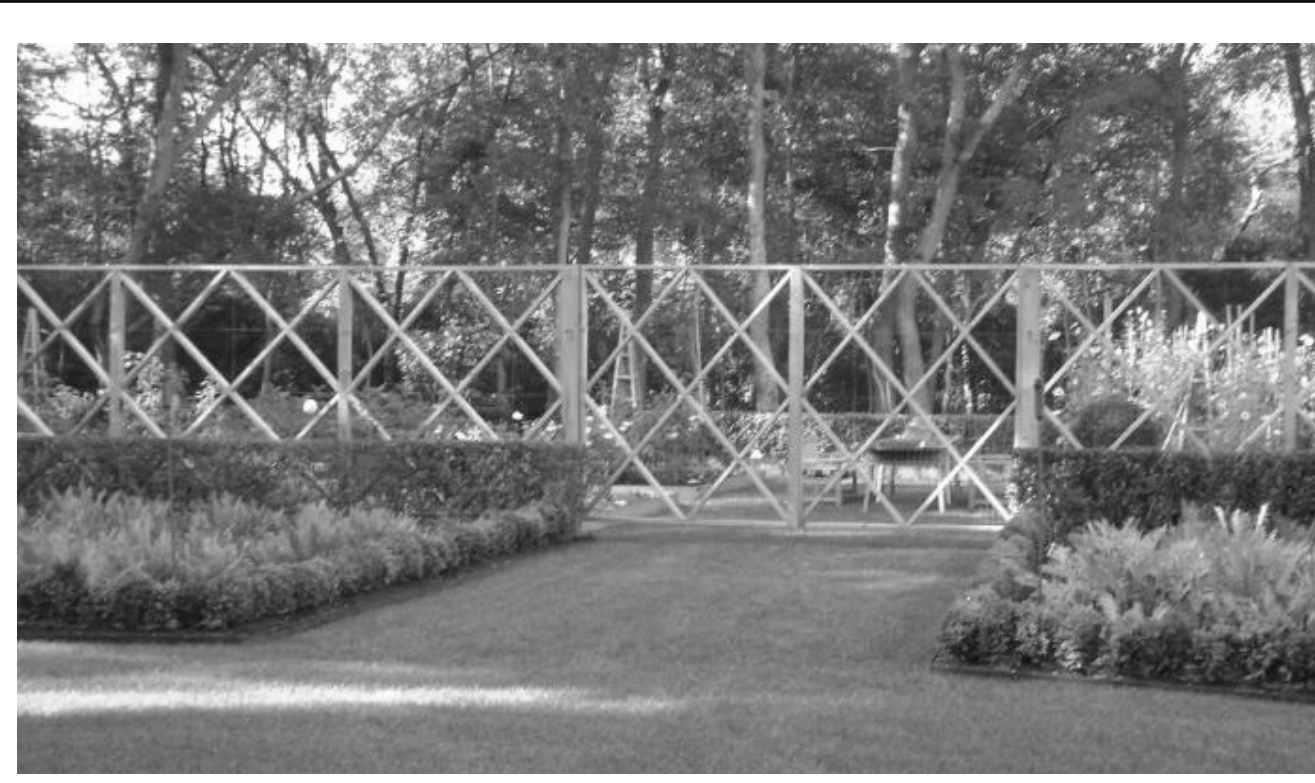

ORNAMENTAL FENCE STAINED PRESSURE TREATED WOOD, COLOR TO BE DETERMINED 8' X 8' W - SIZE MAY BE MODIFIED, BUT STYLE TO REMAIN THE SAME GATES TO BE SINGLE, NOT DOUBLE AS SHOWN

Scale: N/A
Date: March 12, 2025
Page: 3 of 3

MURRAY RESIDENCE
45 Forest Rd. Biltmore Forest, NC 28803
Final Landscape Plan

3 Chestnut Mountain Ridge
Asheville, NC 28803
828.628.4922



PLANT LIST

Color Garden	Notes	Common Name	Botanical Name	Quantity	Installed Size
Climber		Clematis	Clematis 'Jackmanii'	4	1 gal
Climber - fragrant		Rose	R. 'Zepherin Drouin'	4	bareroot
Climber - fragrant		Wisteria - American	Wisteria frutescens	2	3 gal
Conifer		Upright Plum Yew	Cephalotaxus harringtonia 'Fastigiata'	25	3' - 4'
Low Perennials		Catmint	Nepeta 'Summer Magic'	12	1 gal
Low Perennials		Gloriosa Daisy	Rudbeckia hirta	12	1 gal
Low Perennials		Hardy Geranium	Geranium 'Rozanne'	4	1 gal
Low Perennials		Lady's Mantle	Alchemilla mollis	12	1 gal
Ornamental Grass		Switchgrass	Panicum virgatum 'Shenandoah'	50	plug
Shrub		Dwarf Oakleaf Hydrangea	Hydrangea quercifolia 'Pee Wee'	11	3 gal
Shrub		Glossy Abelia	Abelia grandiflora	3	3 gal
Shrub		Hydrangea	Hydrangea macrophylla 'Endless Summer'	9	3 gal
Shrub - fragrant		Paperbush	Edgeworthia chrysantha	1	3 gal
Shrub - fragrant		Rose	David Austin selections TBD	4	bareroot
Shrub		Sumac	Rhus aromatica 'Gro-Low'	13	3 gal
Shrub - evergreen		Hoogandorn Holly	Ilex crenata 'Hoogandorn'	24	3 gal
Tall Perennials		Gaura	Gaura lindheimeri 'Whirlwind'	6	1 gal
Tall Perennials		Japanese Anemone	Anemone 'Honorine Jobert'	6	1 gal
Tall Perennials		Penstemon	Penstemon 'Onyx & Pearls'	6	1 gal
Tall Perennials		Peony	Paeonia 'Sarah Bernhardt'	6	1 gal
Tall Perennials		Purple Coneflower	Echinacea purpurea 'Magnus'	6	1 gal
Tall Perennials		Siberian Iris	Iris siberica 'Caesar's Brother'	6	1 gal
Total				228	

NOTES

Installation Notes: General	
Utilities	Utilities will be marked prior to work commencing. Homeowner to call 811
Utilities	There is newly-repaired sewer line running down the central slope and an old water line that is shown on an old survey.
Hardscape	Installer will consult on materials and construction to best meet design concepts. Homeowner will approve all hardscape materials prior to construction.
Amendment	Amendment will be mainly pine fines with some compost. The purpose is primarily to add air pockets into soil.
Plant removals/transplants	All plant removals will be flagged with red tape. Transplants will be flagged with green tape
Plant layout	Designer will approve woody plant layout and will direct perennial plant layout.
Watering	Installer will ensure that new plantings are well-watered in. Homeowner will assume responsibility for ongoing watering.
Planting time	Woody plants may be planted in spring - early summer and fall - early winter
Planting time	Herbaceous plants may be planted in spring - early summer
Landscape Lighting	Installer will collaborate on a landscape lighting plan. The quote for this feature will be separate from the general installation quote.
Installation Notes: Driveway & Stone Wall / Edge	
Removal	The stone steps above the driveway will be removed and the slope graded.
Stabilization	The existing hedge along the driveway will be removed. Jute mesh will replace this material just before planting.
Asphalt Drive	Homeowner and Installer will agree on driveway contractor and responsibilities. Asphalt will be removed, drive re-graded, wall laid, asphalt applied.
Drainage	Drainage for the wall and driveway will be agreed upon by Installer and Driveway Contractor, approved by Homeowner/Designer.
Driveway width	The original survey had the driveway at 12' wide. That has eroded to 10' wide.
	The new drive is to be widened (shown on plan) at the turnings, and relaid at the original width of 12' in the straights.
Stone Wall	The wall between the new front steps and the lower driveway turn will be 20" - 24" high, TN Fieldstone medium long.
Stone Edge	The edge between the new front steps and the parking court will be 9" - 12" high, TN Fieldstone small long.
Stone Style	Stone wall will have dry-laid look, similar to 9 Fairway golf course side wall, but with larger stone. See photo on plan.
Installation Notes: Stone Steps & Handrails	
Step riser & tread	All steps to be TN Fieldstone steppers, 3" - 4" wide (nominal). Riser will be 5" consistent. Tread will vary based on slope.
Handrail	Handrail will be custom made to curve with steps, metal powder-coated black. Post & rail, no pickets.
Handrail	Rail profile to be approved by Homeowner / Designer. Rail end to be long lamb's tongue.
Cheek Walls	Any steps that require side support will have cheek walls of TN Fieldstone Medium Long.
Installation Notes: Front Walk	
Removal	The existing concrete walk will be removed. A large stump near this walk will also be removed.
Layout	Designer will flag the new walk placement (shown on plan). The walk will be 6' wide.
Layout	The side path leading to the steps will be 4' wide.
Style	The style shown in the photograph indicates the desired size and color variation.
Stone	The stone will be large Crab Orchard flagging. Colors to be approved by Homeowner / Designer
Joint	The stones will be mortared. Installer to describe polymeric (vs traditional mortar) and use that if Homeowner approves.

Installation Notes: Color Garden	
Layout	The Color Garden will be 40' x 24'.
Grading	The area will be graded flat and will be supported by stone edging above and / or below the garden area.
Hardscape	Stone steps will be installed. Gravel path leading to the garden will have stone edging support
Hardscape	Gravel paths inside the garden will have a metal edge. Paths will have 3" compacted fines with 1" gravel to finish.
Fence	The fence will be custom as shown in photograph, with two gates. Gates will be single and match fence pattern.
Fence	The fence will be made from pressure treated wood and stained (color TBD).
Fence	The fence shown is 8' tall. This design may be modified to 6' tall as long as the pattern can be adapted.
Fence	The link below is an article in which this particular fence design is described: https://www.gardenista.com/posts/the-landscape-designer-is-an-elegant-deer-fencing-hampton-edition/
Fountain	Installer will install fountain and electrical access for a small recirculating pump.
Fountain	Fountain to be purchased by Homeowner, Installer to receive delivery.
Feature	https://www.uniquegardendecor.com/product/longmeadow-fountain/?gad_source=1 Benches will be purchased by Homeowner and assembled by Installer.
Feature	https://www.countrycasualteak.com/collections/windermere-bench-collection/teak-garden-bench-windermere-curved-4508
Feature	Pots & plants will be selected by Homeowner / Designer. Installer will place, fill and plant at Designers direction.
Amendment	All planting beds will be turned to 10", amended with 3" planting mix, and re-turfed.
Planting	Designer will approve woody plant layout, and assist with perennial plant layout.
Mulch	Climber placement is not shown on plan. These will be planted to grow on the fence. Designer to indicate placement.
Watering	Mulch will be 3" double ground pine bark inside the fence. Outside, mulch will be pine straw. All plants will be well-watered in; ongoing watering is the responsibility of Homeowner.

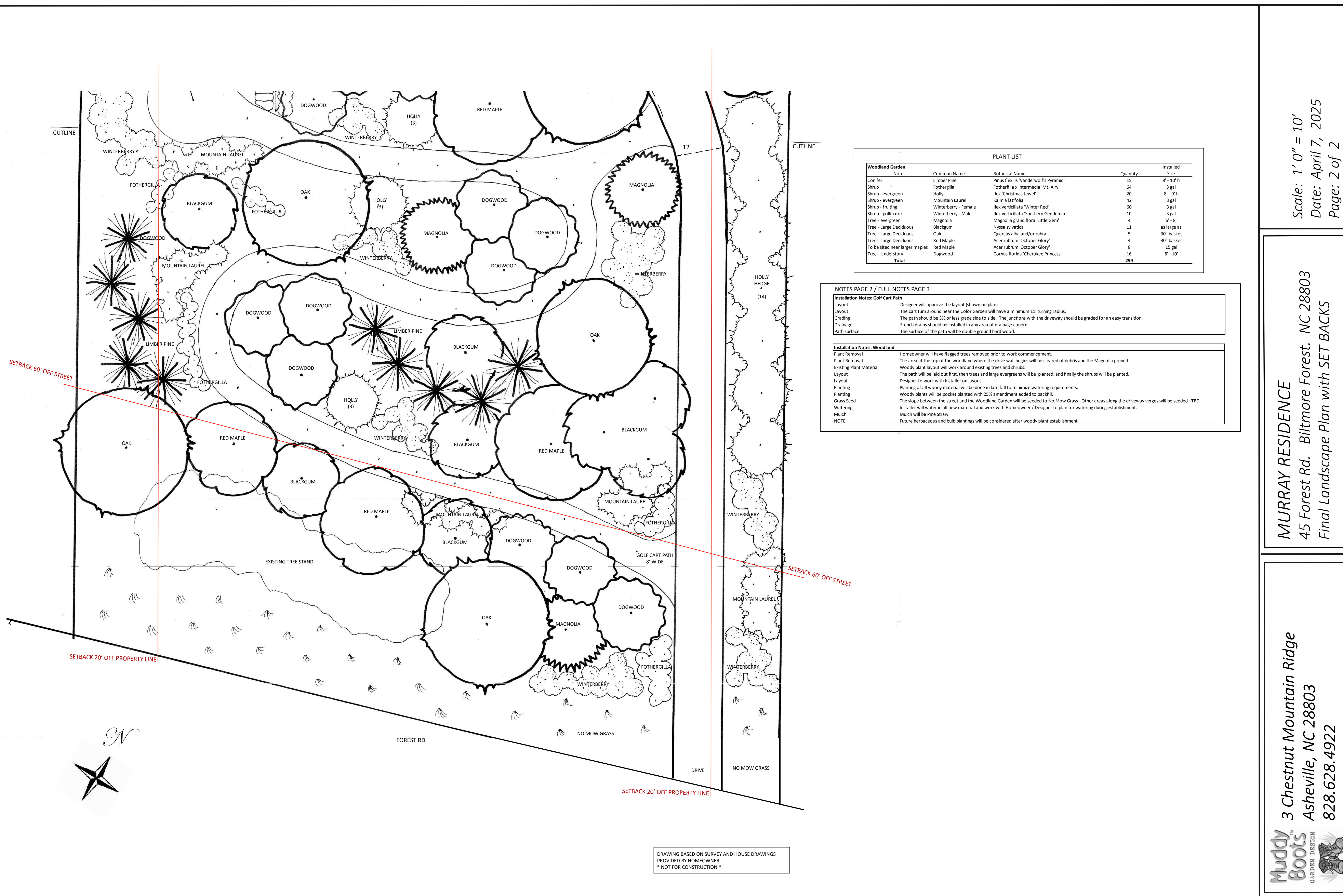

PLANT LIST

Woodland Garden Notes	Common Name	Botanical Name	Quantity	Installed Size
Conifer	Limber Pine	Pinus flexilis 'Vanderwolf's Pyramid'	15	8' - 10' h
Shrub	Fothergilla	Fothergilla x intermedia 'Mt. Airy'	64	3 gal
Shrub - evergreen	Holly	Ilex 'Christmas Jewel'	20	8" - 9" h
Shrub - evergreen	Mountain Laurel	Kalmia latifolia	42	3 gal
Shrub - fruiting	Winterberry - Female	Ilex verticillata 'Winter Red'	60	3 gal
Shrub - pollinator	Winterberry - Male	Ilex verticillata 'Southern Gentleman'	10	3 gal
Tree - evergreen	Magnolia	Magnolia grandiflora 'Little Gem'	4	6' - 8'
Tree - Large Deciduous	Blackgum	Nyssa sylvatica	11	as large as
Tree - Large Deciduous	Oak	Quercus alba and/or rubra	5	30" basket
Tree - Large Deciduous	Red Maple	Acer rubrum 'October Glory'	4	30" basket
To be sited near larger maples	Red Maple	Acer rubrum 'October Glory'	8	15 gal
Tree - Understory	Dogwood	Cornus florida 'Cherokee Princess'	16	8' - 10'
Total			259	

NOTES PAGE 2 / FULL NOTES PAGE 3

Installation Notes: Golf Cart Path

Layout: Designer will approve the layout (shown on plan)

Layout: The cart turn around near the Color Garden will have a minimum 11' turning radius.

Grading: The path should be 3% or less grade side to side. The junctions with the driveway should be graded for an easy transition.

Drainage: French drains should be installed in any area of drainage concern.

Path surface: The surface of the path will be double ground hard wood.

Installation Notes: Woodland

Plant Removal: Homeowner will have flagged trees removed prior to work commencement.

Plant Removal: The area at the top of the woodland where the drive wall begins will be cleared of debris and the Magnolia pruned.

Existing Plant Material: Woody plant layout will work around existing trees and shrubs.

Layout: The path will be laid out first, then trees and large evergreens will be planted, and finally the shrubs will be planted.

Layout: Designer to work with Installer on layout.

Planting: Planting of all woody material will be done in late fall to minimize watering requirements.

Planting: Woody plants will be pocket planted with 25% amendment added to backfill.

Grass Seed: The slope between the street and the Woodland Garden will be seeded to No Mow Grass. Other areas along the driveway verges will be seeded. TBD

Watering: Installer will water in all new material and work with Homeowner / Designer to plan for watering during establishment.

Mulch: Mulch will be Pine Straw.

NOTE: Future herbaceous and bulb plantings will be considered after woody plant establishment.

Scale: 1' 0" = 10'
 Date: April 7, 2025
 Page: 2 of 2

MURRAY RESIDENCE
 45 Forest Rd. Biltmore Forest. NC 28803
 Final Landscape Plan with SET BACKS

3 Chestnut Mountain Ridge
 Asheville, NC 28803
 828.628.4922

DRAWING BASED ON SURVEY AND HOUSE DRAWINGS
 PROVIDED BY HOMEOWNER
 * NOT FOR CONSTRUCTION *



SETBACK 20' OFF PROPERTY LINE

SETBACK 20' OFF PROPERTY LINE

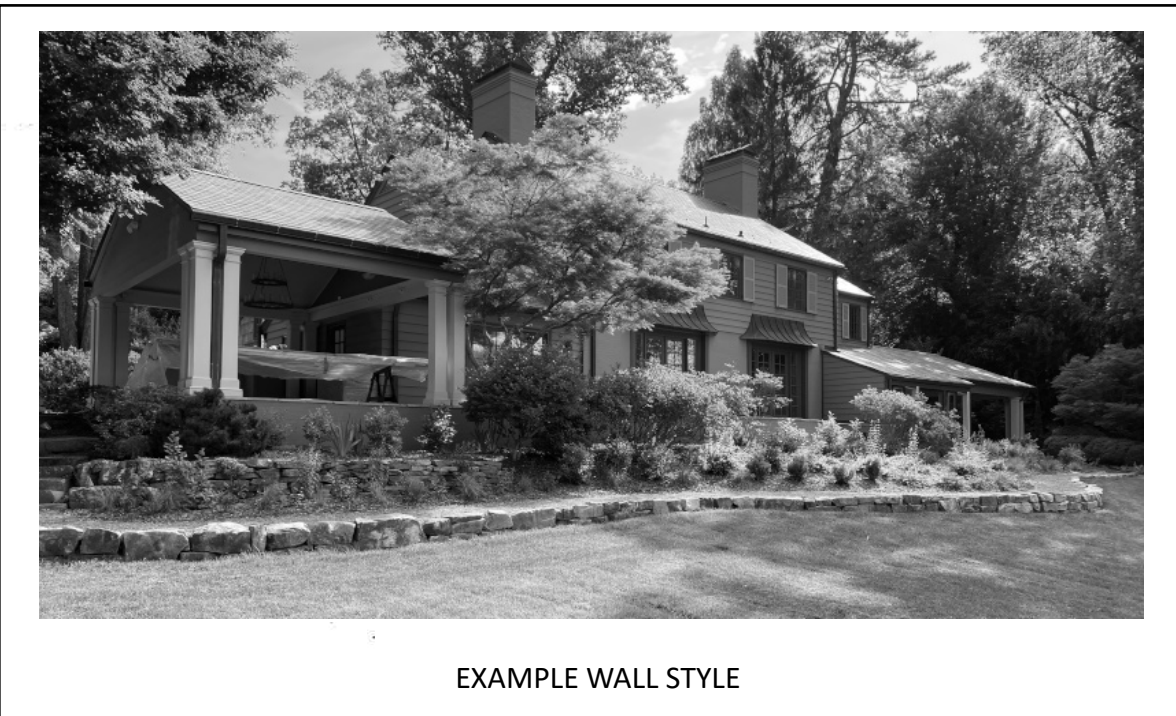
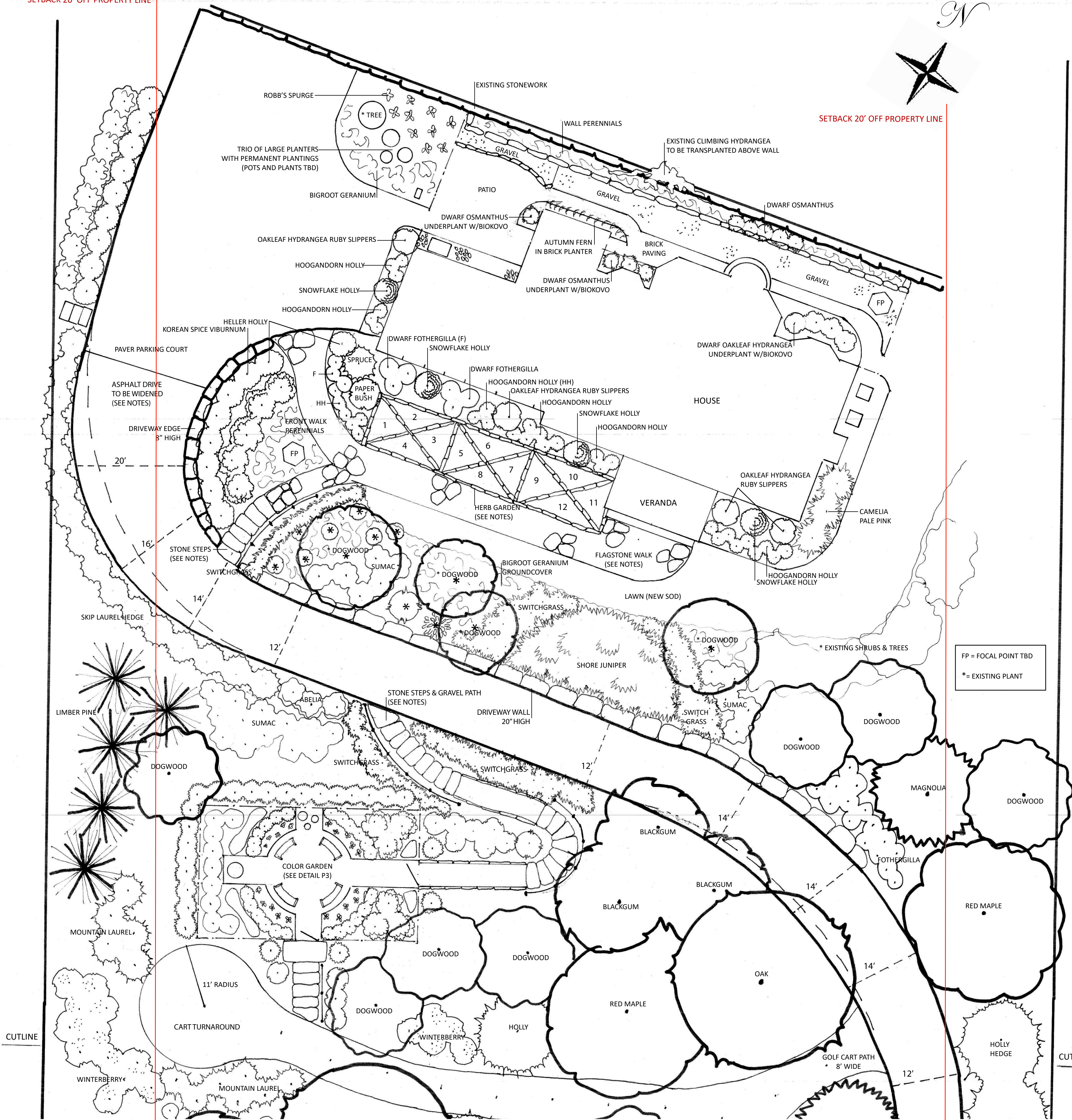

EXAMPLE WALL STYLE

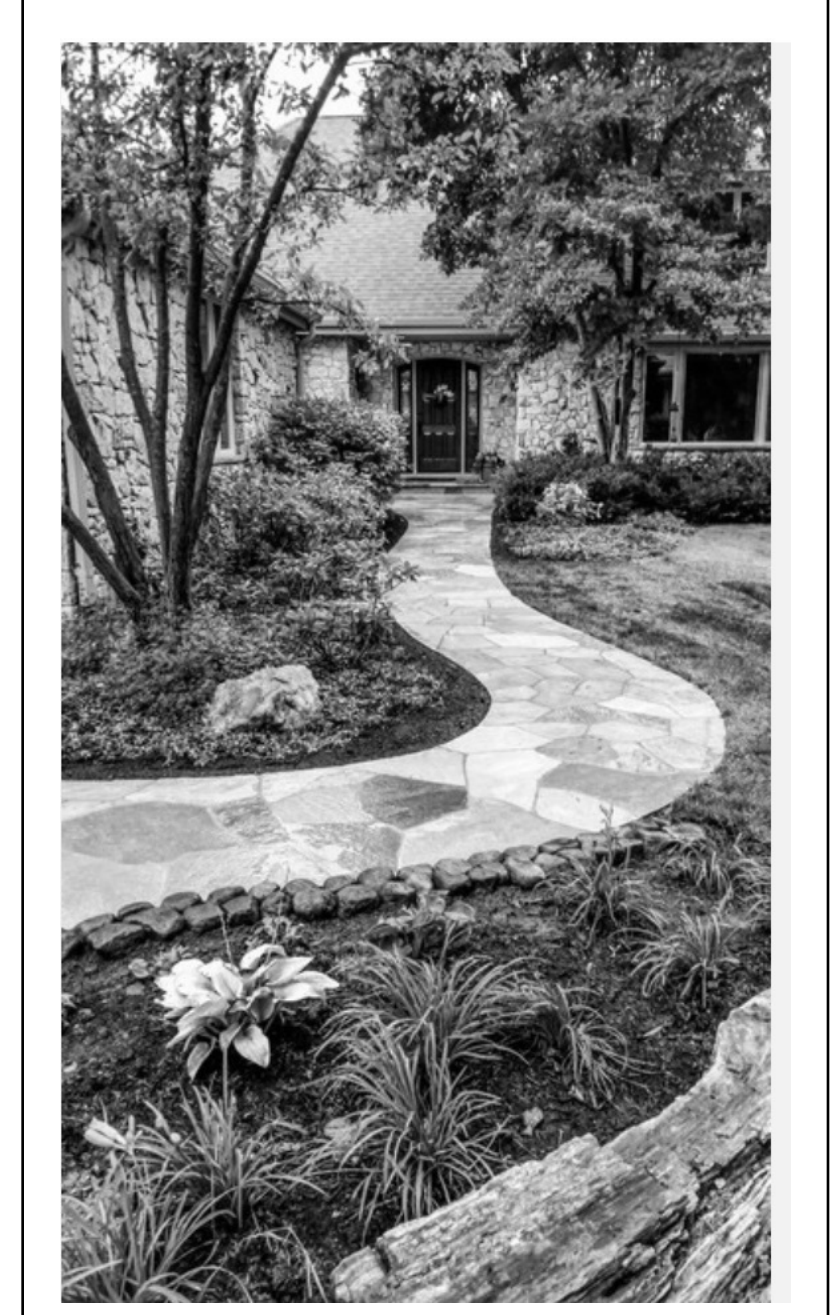

EXAMPLE FRONT WALK STYLE

PLANT LIST

Notes	Common Name	Botanical Name	Quantity	Installed Size
Front & Side of House				
Conifer	Shore Juniper	Juniperus conferta 'Blue Pacific'	30	1 or 3 gal
Conifer	Spruce	Picea abies 'Columnaris'	1	6' - 8' tall
Front Walk Perennials	Bee Balm	Monarda 'Raspberry Wine'	6	1 gal
Front Walk Perennials	Bluestar	Ansonia hubrechtii	3	1 gal
Front Walk Perennials	Catmint	Nepeta 'Summer Magic'	6	1 gal
Front Walk Perennials	Gloriosa Daisy	Rudbeckia hirta	6	1 gal
Front Walk Perennials	Lamb's Ears	Stachys byzantina 'Helen von Stein'	6	1 gal
Front Walk Perennials	Russian Sage	Perovskia 'Denim and Lace'	6	1 gal
Front Walk Perennials	Salvia	Salvia sylvestris 'Caradonna'	6	1 gal
Front Walk Perennials	Switchgrass	Panicum virgatum 'Shennandoah'	12	1 gal
Groundcover	Bigroot Geranium	Geranium macrorrhizum	150	plug
Herb Garden: 1, 5, 9	Rosemary	Herb	9	qt
Herb Garden: 1, 5, 9	Tarragon	Herb	9	qt
Herb Garden: 2, 6, 10	Lavender	Herb	18	1 gal
Herb Garden: 2, 6, 10	Peony	Herb	9	1 gal
Herb Garden: 2, 6, 10	Thyme	Herb	18	qt
Herb Garden: 3, 7, 11	Marjoram	Herb	9	qt
Herb Garden: 3, 7, 11	Oregano	Herb	9	qt
Herb Garden: 4, 8, 12	Basil	Herb	9	qt
Herb Garden: 4, 8, 12	Dill	Herb	9	qt
Herb Garden: 4, 8, 12	Parsley	Herb	9	qt
Herb Garden: 4, 8, 12	Germander	Herb	27	qt
Ornamental Grass	Switchgrass	Panicum virgatum 'Shennandoah'	50	plug
Shrub	Dwarf Fothergilla	Fothergilla gardenii 'Blue Shadow' if available	9	3 gal
Shrub	Glossy Abelia	Abelia grandiflora	8	3 gal
Shrub	Oakleaf Hydrangea	Hydrangea quercifolia 'Ruby Slippers'	4	
Shrub	Sumac	Rhus aromatica 'Gro-Low'	11	3 gal
Shrub - evergreen	Camelia	Camelia japonica 'Pink Perfection' or 'High Fragrance'	3	7 gal
Shrub - evergreen	Heller Holly	Ilex crenata 'Helleri'	18	3 gal
Shrub - evergreen	Hoogandorn Holly	Ilex crenata 'Hoogandorn'	43	3 gal
Shrub - evergreen	Skip Laurel	Prunus taurocerasis 'Skiolaensis'	16	6" tall
Shrub - evergreen	Snowflake Holly	Ilex crenata 'Shiro Fukurin'	4	4" h
Shrub - fragrant	Korean Spice Viburnum	Viburnum carlesii	5	7 gal
Shrub - fragrant	Paperbush	Edgeworthia chrysantha	1	3 gal
Total			539	
Back of House				
Climber - transplant	Climbing Hydrangea	Hydrangea anomala	1	n/a
Groundcover	Bigroot Geranium	Geranium macrorrhizum	50	plug
Groundcover	Hardy Geranium 'Blokovo'	Geranium x cantabrigense 'Blokovo'	50	plug
Groundcover	Robb's Spurge	Epimedium robiae	50	plug
Perennial - brick planter	Autumn Fern	Dryopteris erythrosora 'Brilliance'	12	1 gal
Perennial - trailing over wall	Creeping Jenny	Lysimachia nummularia 'Aurea'	12	1 gal
Perennial - wall planter	Cinnamon Fern	Osmunda cinnamomea	12	1 gal
Perennial - wall planter	Coral Bells	Heuchera villosa 'Autumn Bride'	12	1 gal
Perennial - wall planter	Hakone Grass	Hakonechloa macra 'All Gold'	12	1 gal
Perennial - wall planter	Hellebore	Helleborus orientalis 'Maestro'	12	1 gal
Shrub	Dwarf Oakleaf Hydrangea	Hydrangea quercifolia 'Pee Wee'	4	3 gal
Shrub - evergreen	Dwarf Osmanthus	Osmanthus heterophyllus 'Karoi Hime'	9	3 gal
Total			236	

NOTES PAGE 1 / FULL NOTES ON PAGE 3

Installation Notes: Front and Side of House
 Plant Removal: All existing foundation shrubs will be removed. One large Rhododendron will be removed and the slope cleared at designers direction.
 Pruning: The existing Dogwoods in the front yard will be pruned at Designers direction.
 Hardscape: New walks & steps will be installed.
 Herb Garden: Herb Garden will be edges with Crab Orchard Curbing. Designer to approve layout.
 Amendment: Planting areas will be amended with 2" - 3" planting mix.
 Planting: Designer will approve woody layout and assist with herb and perennial layout.
 Planting the slope: The slope where the Juniper, Switchgrass, and Sumac will be planted will be underlaid with jute mesh to help with establishment.
 Planting above side wall: The area above the wall will be cleared of debris, soil and amendment added to create an even planting bed for Abelia and Holly.
 Planting the Skip Hedge: As the Drive will be widened, Installer to recommend slope support for the large Skip Laurel Hedge.

Installation Notes: Back of House
 Plant Removal: English Ivy will be removed from brick planter, stone planter and above wall.
 Plant Removal: All shrubs will be removed from wall planter and foundation beds, with one to be transplanted.
 Transplant: One Climbing Hydrangea will be transplanted above the wall. Designer to flag.
 Gravel: The area that was sod, will be gravel. All remaining vegetation will be removed, a 2" - 3" layer of fines compacted, a 1" layer of gravel to finish.
 Gravel: Gravel will be small Nollchucky.
 Amendment: Planting areas will be amended with 2" - 3" planting mix.
 Planting: Designer will layout perennials and approve shrub placement.
 Planting: Groundcover plugs outside of picket fence will have amendment spread over surface and dug in as plugs are planted.
 Mulch: Mulch will be double ground pine bark mulch.
 Watering: Installer will water in all new plants; Homeowner will be responsible ongoing.
 Feature: The three pots and permanent plantings outside the picket fence will be chosen by Homeowner / Designer. This will be a separate cost.
 Feature: The Focal Point on axis in the gravel area will be chosen by Homeowner / Designer. This will be a separate cost.

DRAWING BASED ON SURVEY AND HOUSE DRAWINGS PROVIDED BY HOMEOWNER *NOT FOR CONSTRUCTION*

Scale: 1' 0" = 10'
 Date: April 7, 2025
 Page: 1 of 2

MURRAY RESIDENCE
 45 Forest Rd. Biltmore Forest, NC 28803
 Final Landscape Plan with SET BACKS

3 Chestnut Mountain Ridge
 Asheville, NC 28803
 828.628.4922

